

Radio Engineering

NOVEMBER, 1936

VOL. XVI

NO. 11

DESIGN • PRODUCTION • ENGINEERING

Broadcast Receivers
Auto-Radio Receivers
Electric Phonographs
Sound Recorders
Sound Projectors
Audio Amplifiers
P-A Equipment
Electronic
Control Devices
Testing and
Measuring Equipment
Television Apparatus
Loudspeakers
Components
Tubes
Photocells



ATTENTION OF:

Pres. _____ V. Pres. _____
Gen. Mgr. _____ Adv. Mgr. _____
Eng. Dept. _____ Prod. Mgr. _____
Sales Mgr. _____ Pur. Agt. _____

The Journal of the
Radio and Allied Industries

SMALL IN SIZE *but*
 PLENTY OF RESERVE
 FOR OVERLOAD

ACTUAL
 SIZE



The efficiency of Erie Insulated Resistors is not impaired by their small size. As the chart at the left shows, Erie 1/4" x 7/16" Insulated Units will safely carry a 100% overload with but a small change in resistance value. Not only is the maximum change less than 4.0%, but recovery occurs quickly and the resistance value is stabilized around 2.4% after approximately 1400 hours.

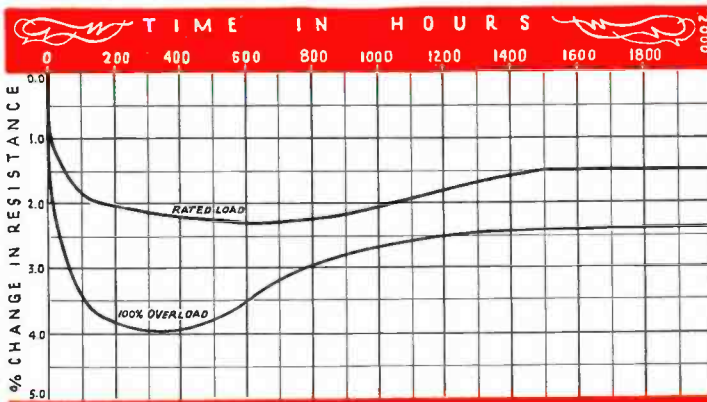

Load Characteristic 1/4 WATT Erie INSULATED RESISTORS

In many instances set manufacturers are using 1/4 watt Erie Insulated Resistors in installations calling for normal loads of 1/3 and 1/2 watts with complete satisfaction.

It pays to use dependable Erie Insulated Resistors.

CARBON RESISTORS
 AND SUPPRESSORS

**ERIE RESISTOR
 CORPORATION**

AUTOMATIC INJECTION
 MOLDING

TORONTO **ERIE, PENNSYLVANIA** LONDON

RADIO ENGINEERING

REG. U. S. PATENT OFFICE

W. W. WALTZ • Editor

CONTENTS FOR NOVEMBER

FEATURES

EDITORIAL	2
THE "MAGIC BRAIN" RECEIVER..... By K. A. Chittick	5
JUNCTION RECTIFIERS..... By Bernard H. Porter	8
RMA'S RECOMMENDATIONS ON ALLOCATION..... By L. C. F. Horle	10
FREQUENCY-MODULATED GENERATORS..... By A. W. Barber	14
SOME NOTES ON LUMINESCENCE..... By Gilbert C. Schmidling	21
CONTROLLING REGENERATION..... By Gilbert Oberweiser	24

DEPARTMENTS

RMA NEWS	30
NEW PRODUCTS	32
INDEX OF ADVERTISERS.....	35

Copyright 1936—Bryan Davis Publishing Co., Inc.

COVER ILLUSTRATION

FIFTY CAVITY MOLD WITH MICA CAPACITORS "HOT" FROM THE PRESS. (Solar Mfg. Corp.)

PUBLISHED MONTHLY by the

VOL. XVI

Member Audit Bureau of Circulations

NO. 11

BRYAN S. DAVIS • President SANFORD R. COWAN • Advertising Manager
JAS. A. WALKER • Secretary A. B. CARLSEN • Circulation Manager

BRYAN DAVIS PUBLISHING CO., Inc. 19 East 47th St., NEW YORK CITY Telephone PLaza 3-0483

CHICAGO OFFICE—608 S. Dearborn St.—C. O. Stimpson, Mgr. Telephone: Wabash 1903

CLEVELAND OFFICE—10515 Wilbur Ave.—J. C. Munn, Mgr. Telephone: Republic 0905-J

MELBOURNE, AUSTRALIA—McGill's Agency

WELLINGTON, NEW ZEALAND—Te Aro Book Depot

Entered as second class matter August 26, 1931, at the Post Office at New York, N. Y., under Act of March 3, 1879. Yearly subscription rate \$2.00 in United States and Canada; 25 cents per copy. \$3.00 in foreign countries; 35 cents per copy.

Editorial

THIS MONTH

ALL ROADS LEAD to Rochester! Exactly one week hence things will be getting under way, and we shall be listening to the first of what promises to be an outstanding program of technical papers. Of the convention itself, more later.

We are pleased to be able to present Mr. Horle's able discussion on RMA's interest in broadcast allocation problems. The idea of a protected frequency, or frequencies, for the exclusive use of receiver intermediate-frequency amplifiers can be appreciated by all.

Our engineering chart—which is reproduced through the courtesy of The Brush Development Company—is of interest in that, so far as we can determine, it shows for the first time the range of ordinary and some not-so-common sounds in terms of the newly adopted sound-pressure and power-level units.

Also, frequency modulation applied to signal generators; an introduction to the subject of luminescence—with a lot of easily confused terms defined; more on regeneration and its control; and junction rectifiers.

ROUND 3

LAST MONTH'S EDITORIAL, "Tubes and Tube Numbers," seems to have struck fire. At any rate, there has been comment; and again the suggestion that we trot out our own pet tube numbering system. Some of these days we will do just that, but in the meantime there are some apparently irreconcilable difficulties which will have to be ironed out.

On the other hand, the question of permanently doing away with old tube types has found wide favor. The chief objection runs about like this: Suppose that a group of tube manufacturers get together and decide to refuse—after a suitable warning period—to offer any more of the old tubes. That will be swell until some fly-by-night chiseler figures that he can clean up by flooding the market with the abandoned types.

This angle has been considered, too. We believe that a situation of this kind can be handled by any of several means; for instance, the patent regulations, trade practice agreements with governmental assistance in weeding out the violators, and straight salesmanship.

Probably this latter is all that will be necessary. Incomes are up, and going higher, and any kind of an intelligently

conducted sales campaign should yield real results.

JUST BETWEEN ENGINEERS

"INDUSTRIAL RESEARCH IS just an insurance policy on your business.

"Research is one of the things you don't undertake until you need it—then it's too late. It's like calling a fire insurance agent after your house is on fire.

"One thing that is never welcome is a snooper from the business office.

"Scientific research is scientific after it's done, but while doing it, it is quite accidental.

"Some failures are thresholds to success—be careful about throwing them away.

"If a thing won't work, find out why. Sometimes that is worth more than the experiment itself.

"Always attack a problem in some direction—but the least likely one is usually right.

"Motion is more important in research than intelligence.

"You can go too far behind times and go broke or you can go too far ahead and go broke.

"Problems are solved in some guy's head—all the research machinery is just to get the idea straight in his mind."

The speaker? C. F. Kettering of General Motors.

GENTLEMEN OF THE PRESS— ON TELEVISION

AS IS USUALLY the case, the boys from the daily and Sunday papers have the answer to television all locked up and ready to go.

For instance, although the Rochester-bound engineers don't suspect it, they are to hear practically nothing but television. We have, as our authority, a radio expert on one of the leading New York afternoon papers.

Even the Herald-Tribune descends from its peak long enough to inform us, via the editorial page, just how television is to be "licked."

None of the boys, however—with the possible exception of the "science" writers on one newspaper chain which has always been noted more for noise than for accuracy—are sticking their necks out in predicting just when the great American public can buy a television receiver on Cortlandt Street for \$7.95.

But, with assistance of this kind, can the final answer be more than a week or so away?

SHAKEPROOF

LET YOUR OWN EYES TELL YOU
what this *triple-action* lock can do

You can believe what you actually see—that's why we urge you to send today for the Free Shakeproof Test Ring and discover for yourself why Shakeproof Lock Washers do lock tighter and definitely defy vibration. We want you to particularly notice the exclusive shape of the teeth on each washer. They are twisted and tapered to provide a powerful combination of three vital locking principles, which are: strut-action, a powerful leverage that resists any backward movement of the nut; spring-tension, the force that assures a constantly tight lock; and line-bite, the positive locking action of each tooth—even at initial contact. Shakeproof Lock Washers will prove themselves worthy of being specified for your regular production because they are used on thousands of America's leading metal products and have never failed to give absolute protection against the damaging effects of vibration. Mail the coupon today for your free test ring!

SHAKEPROOF LOCK WASHER CO.

Distributor of Shakeproof Products Manufactured by Illinois Tool Works
2509 N. Keeler Avenue Chicago, Illinois
In Canada: Canada Illinois Tools, Ltd., Toronto, Ont.
Copr. 1936 Illinois Tool Works

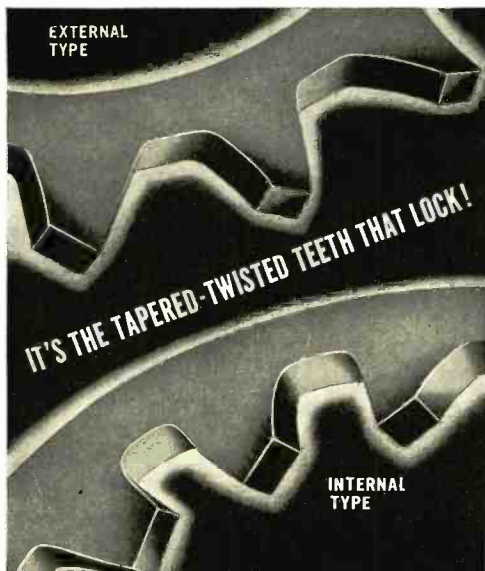

U. S. Patent Nos.
1,862,486 1,909,476
1,909,477 1,419,564
1,782,387 1,604,122
1,963,800
Other Patents.
Patents Pending.
Foreign Patents.



Mail THIS
COUPON
TODAY!



MAKE THIS CONVINCING 3-WAY TEST

STRUT-ACTION

Turn a nut down tight against a Shakeproof Lock Washer—then loosen this nut and, as you push the wrench, feel the powerful resistance set up by the bite of the tapered-twisted teeth—that's Strut-Action!



SPRING-TENSION

Place a Shakeproof Lock Washer between two pieces of ordinary steel and insert in the jaws of a vice. As you tighten the vise, watch the teeth bite in deeper—keeping the locking action constantly in force—that's Spring-Tension!



LINE-BITE

Examine a nut after it has been locked by a Shakeproof Lock Washer. The marks of the teeth prove Line-Bite!



SHAKEPROOF LOCK WASHER CO.
2509 N. Keeler Ave., Chicago, Ill.

Gentlemen: Send us the FREE Test Ring so that we may test Shakeproof Lock Washers on our own products.

Firm Name.....
Address.....
City..... State.....
Signed by..... Title.....

WIRE - by - WIRE

Specialties *Specialists*

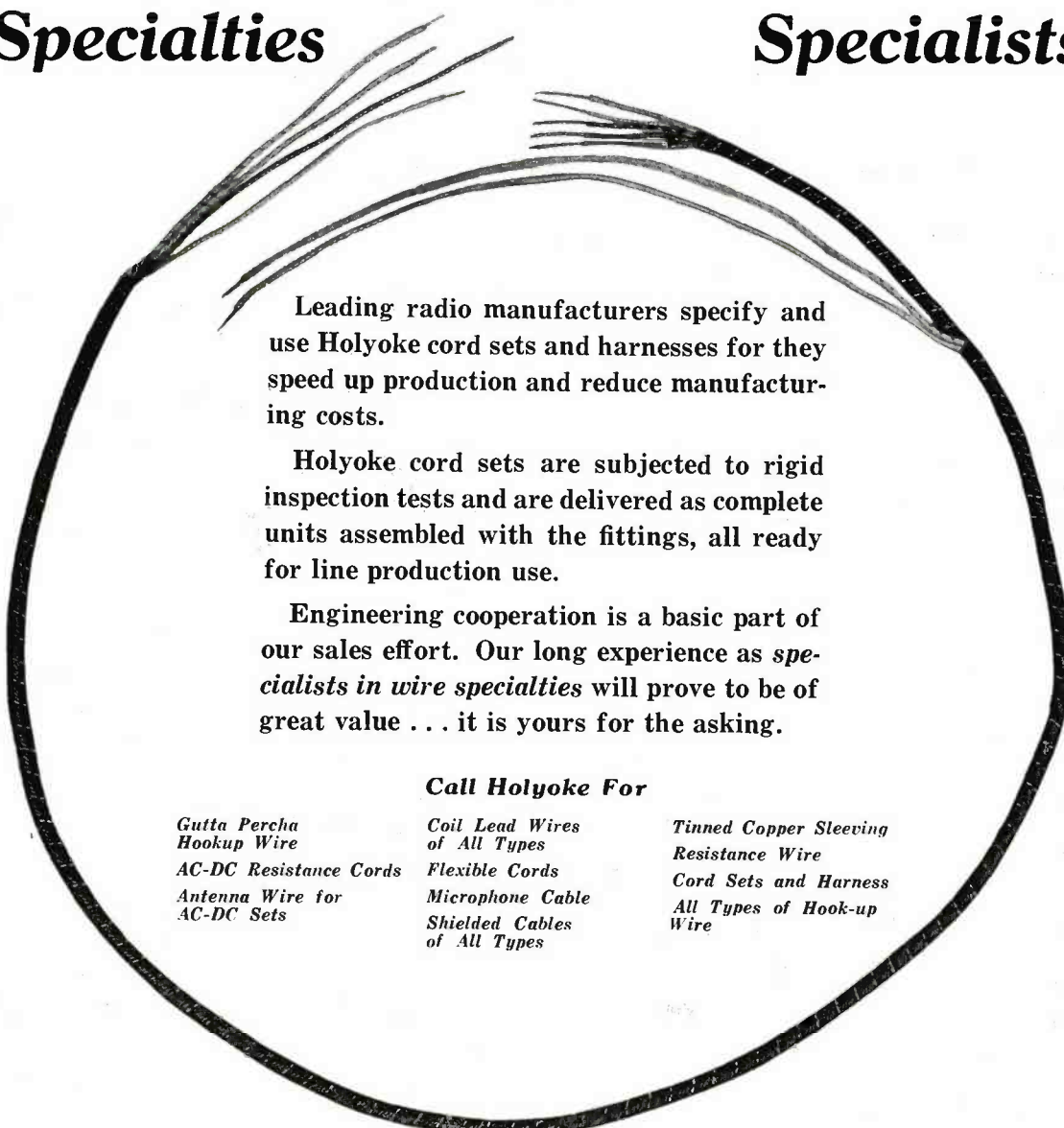

Leading radio manufacturers specify and use Holyoke cord sets and harnesses for they speed up production and reduce manufacturing costs.

Holyoke cord sets are subjected to rigid inspection tests and are delivered as complete units assembled with the fittings, all ready for line production use.

Engineering cooperation is a basic part of our sales effort. Our long experience as *specialists in wire specialties* will prove to be of great value . . . it is yours for the asking.

Call Holyoke For

*Gutta Percha
Hookup Wire*

AC-DC Resistance Cords

*Antenna Wire for
AC-DC Sets*

*Coil Lead Wires
of All Types*

Flexible Cords

Microphone Cable

*Shielded Cables
of All Types*

Tinned Copper Sleeving

Resistance Wire

Cord Sets and Harness

*All Types of Hook-up
Wire*

There is a Holyoke wire, cable, cord or harness assembly for every radio application. Write for samples or let us know your problem.

Holyoke

**The Holyoke Company,
Inc.**

730 Main Street, Holyoke, Mass.

RADIO ENGINEERING

FOR NOVEMBER, 1936

THE "MAGIC BRAIN" RECEIVER

by K. A. Chittick*

THE MAGIC BRAIN IN RCA receivers is the name applied to the shielded unit assembly which contains the radio-frequency coil structure, associated switching circuits, the alignment adjustments for the various frequency bands, and the selector dial mechanism.

The purpose of the Magic Brain is to select and amplify the desired signal, to reject all unwanted signals and to reduce circuit and tube noises or hiss. The Selector Dial mechanism is designed in such a manner that only one frequency band scale is visible at one time, which eliminates the confusion ordinarily present when three or more band scales are visible at all times. A band-spread scale is provided for accurate calibration of short-wave stations. Fig. 1 shows the construction of the Magic Brain with shields in place. Fig. 2 shows the detailed assembly of the various component parts with the shields removed.

The antenna and radio-frequency stage each consists of two coil structures, one containing the windings for the four lowest frequency bands and a separate coil form which contains the winding for the ultra-high-frequency band. In this manner the total number of coils and coil connections is reduced, thus simplifying the wiring to the range switch. Each frequency band is trimmed at the

high-frequency end of the range by a new design air trimmer that has extremely low loss and excellent stability with changes in weather conditions, temperature of the chassis, or aging of the metal parts. No compression type mica trimmers are used in any circuit so the various frequency bands do not require readjustment in the customer's home after a period of service.

The Magic Brain coil structure, consisting of four bands on one coil form, makes use of a newly developed R-F transformer system in which the secondary coil of any one band is used as the primary coil of the next band higher in frequency. In this manner only five separate windings are required for the four wavebands. The A, B, and C band coils are each wound in an accurately threaded groove and are non-adjustable with respect to inductance. The X band primary and X band secondary are the universal type coils and are also wound to the correct inductance without an external adjustment. This system reduces the total number of different windings and results in having a low-loss primary and secondary winding for each waveband. Figs. 3 and 4 show the detailed construction of the various coils.

The D band coils consist of approximately a single turn of a silver plated copper strap $3/16$ " wide wound around a $7/8$ " coil form and coupled to a space-wound primary coil. This coil is mounted directly to the range

*Engineering Department, RCA Manufacturing Co., Inc., Camden, N. J.

Fig. 1.

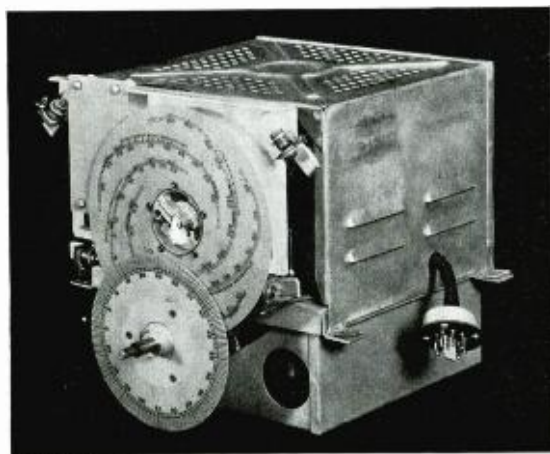
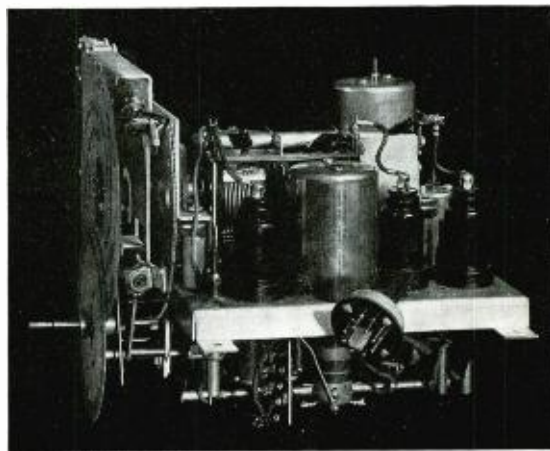

Fig. 2.



switch. All lead connections to the variable condenser and the range switch external to the D band coil are also constructed of silver-plated copper bars in order to reduce the external circuit inductance to a minimum and to maintain absolute uniformity of inductance for correct alignment. The total length of the D band circuit is very important since a variation of $\frac{1}{8}$ " in length will shift the circuit approximately 460 kc at 40 mc. This would bring the detector and oscillator circuits "in step." An excess of solder at any joint in the D band circuit will also shift the inductance an appreciable amount.

The radio-frequency stages function in the following manner:

X Band (150-410 kc) Fig. 5.

On this frequency band the secondary coils C, B, A and X are connected in series and serve as the X band secondary circuit which is trimmed at 350 kc by the air trimmer C_x . The total inductance of the C, B and A coils is only a small percentage of the X band inductance. The ground connection of the coil structure is at the low-potential end of the X band coil as indicated in Fig. 5. The primary coils C_p , D_p and X_p are connected in series in the plate circuit of the radio-frequency amplifier tube with coil X_p acting as the primary which transfers energy to the secondary coil X. The 560-mmfd condenser is shunted across the primary coil X_p and resonates X_p to the proper frequency. Practically no energy is transferred to the secondary circuit by the primary C_p at the X band frequencies nor is the primary coil D_p effective.

Automatic volume control bias is applied to the first detector by the resistor-capacitor network as shown in the figure.

A Band (530-1,800 kc) Fig. 6.

On A band, the secondary coils C, B and A are connected in series to serve as the A band secondary coil which is trimmed at 1,500 kc by the air trimmer C_a . The ground of the coil structure has moved up for this band and is located between coils A and X. The X coil is now used as the primary and is resonated to the proper frequency by the 15 mmfd condenser and the C band trimmer C_c which are connected in shunt with coil X. Coil X is shunted across coil X_p by means of the 560 mmfd condenser. The primary coils C_p and D_p have very little effect at these frequencies.

B Band (1,800-6,300 kc) Fig. 7.

On B band, the coils C and B are connected in series to form the secondary coil and are trimmed at 6,000 kc by the air trimmer C_b . The ground of the secondary structure has now moved up between the A and B coils. Coil A serves as the primary and is resonated to the proper frequency by the 15 mmfd condenser which is connected in shunt with the A coil. Coil X is shorted by the range switch to prevent absorption resonance effects. The 560 mmfd condenser shunts coil A across coil X_p .

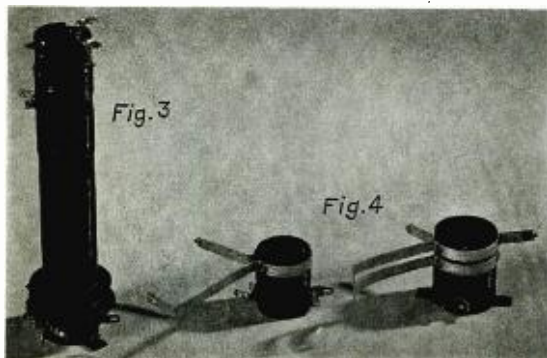

Page 6

The primary coil C_p and D_p have very little effect on this frequency band.

C Band (6,300-22,000 kc) Fig. 8.

On C band, the coil C is the secondary and is trimmed at 20 mc by the air trimmer C_c . The ground of the coil structure is located between the C and B coils with coil B acting as the usual primary and resonated to the proper frequency by the 15 mmfd condenser. In addition, a second primary coil C_p is used. The coil D_p is shunted by the 560 mmfd and the 0.01 mfd condenser in series to remove all effect of this coil. The latter network places coil B in parallel with the coil X_p . Coils X and A are shorted by the range switch on this band to prevent absorption effects. The primary coil C_p reduces the resonant effect of the shorted coil A. Although coil A has a direct short across its terminal connections, it will absorb energy from coil C at the frequency that a standing wave is formed across the coil. This absorption occurs at the high frequency end of C band. The primary coil C_p , which is in series with coil A, isolates coil A from the tuned circuit (A) and thus prevents absorption effects on C band.

D Band (22,000-60,000 kc) Fig. 9.

On band D a radio-frequency stage, working at these ultra-high frequencies, is used for the first time in RCA receivers to increase the sensitivity and improve the image ratio. Coil D is the secondary or grid circuit inductance and is trimmed at 58 mc by the air trimmer C_d . The primary coils C_p and D_p are connected in series on this band. The resonance of coil C_p on this band is increased in frequency because of the decreased distributed capacity in shunt with C_p . The secondary coil D is shunted across coil C thereby removing C effectively from circuit. Coils B, A and X are shorted directly by the range switch as indicated in the diagram.

The antenna stage of the Magic Brain coil system is similar in design to the detector stage with the exception that the primary C_p is omitted. The method of switching circuits is also similar to the detector stage.

This resonant effect of the A coil is also present in the antenna stage, but in this case a tap connection is brought cut from the center of the A coil and shorted to antenna by the range switch to destroy the resonance.

The oscillator stage employs a Hartley-type circuit to increase the frequency stability and to reduce manufacturing variation to a minimum. The main coil structure contains three separate windings for the A, B and C bands which are tapped for the cathode circuit and connected directly to the range switch. The D band and X band circuits are separate coils. Each oscillator coil is trimmed by an air trimmer. The usual adjustable series condensers for the low frequency end of the X and A bands at 600 and 175 kc respectively, are eliminated and fixed impregnated mica condensers substituted. A magnetite inductance adjustment of the A and X band oscillator coils is used for exact alignment at 600 kc and 175 kc.

The D band oscillator circuit employs a low frequency primary coil connected in the plate circuit of the pentode oscillator tube in addition to the regular cathode connection to increase the oscillation strength at the low frequency end of the D band. This primary circuit is ineffective on the other bands.

One of the interesting problems encountered in the design of the D band oscillator and detector circuit was the effect of the natural resonance of the internal elements of the 6L7 detector tube. This resonance effect occurred in all types of tubes tested that contained a succession of positive and negative grids. The D band os-

(Continued on page 28)

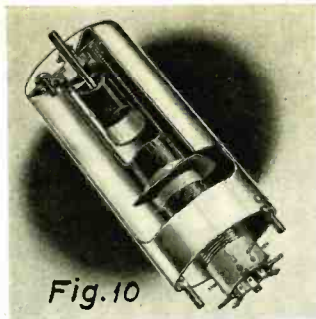

Fig. 10

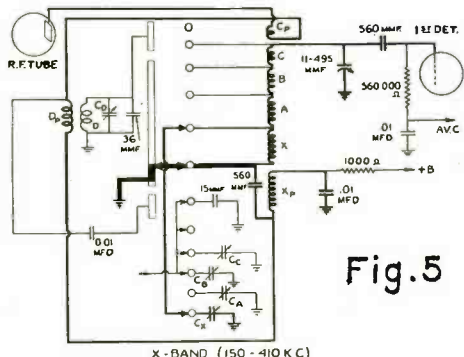

Fig. 5

X-BAND (150-410 K.C.)

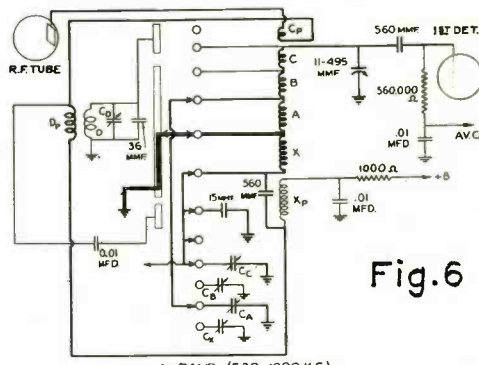

Fig. 6

A-BAND (530-1800 K.C.)

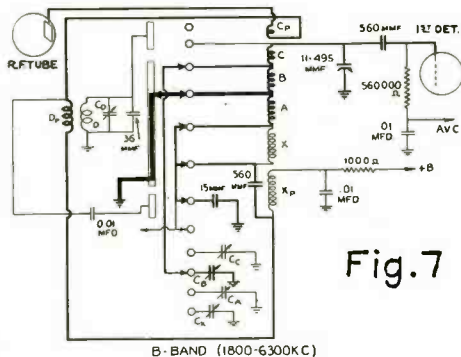

Fig. 7

B-BAND (1800-6300 K.C.)

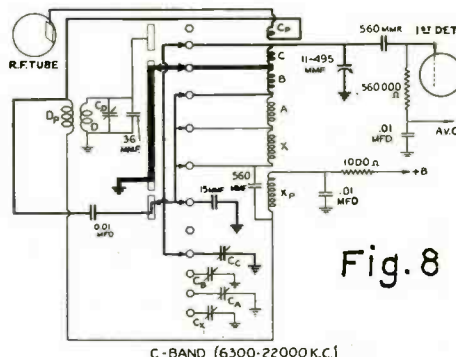

Fig. 8

C-BAND (6300-22000 K.C.)

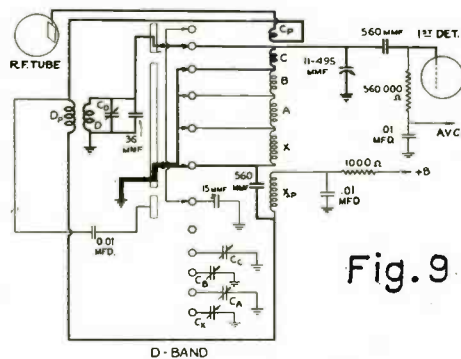
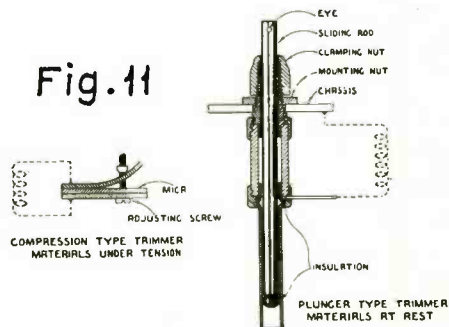

Fig. 9

D-BAND

Fig. 11



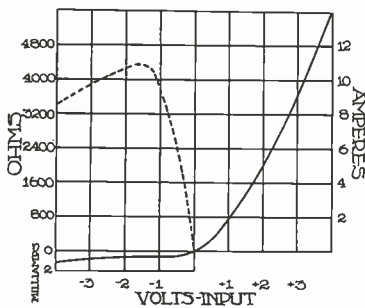

Fig. 1. Volt-ampere characteristic of a copper-copper oxide junction.

OF THE SOLID materials that provide a uni-lateral conductivity at their junction, combinations of copper with copper oxide and cupric sulphide with magnesium have been the most successful in the electrical and industrial field. Trickle chargers, dynamic-speaker power units, B eliminator rectifiers and railway signal rectifiers include some of the commercial devices that utilize this arrangement of substances.

SUPPOSED ACTION

Theoretically, when two surfaces are firmly pressed together and separated by a distance comparable with the spacing of the molecules therein, electrons pass freely across the junction in one direction and are impeded in the other. Point or "cat's whisker" contact between any conductor and a semi-conductor has long been known to possess such an asymmetry in conductivity. In placing a great number of point contacts in parallel, by distributing the asymmetrical resistance over the entire boundary area of cuprous oxide and copper, a sufficiently uniform rectifying action can be attained and a rectifier unit so fabricated. Cuprous oxide and copper, considered individually, do not possess any asymmetry in their electrical conductivities.

The resistance of the rectifier in the direction of the oxide to copper, i. e., from the oxide face-inwards, is low, while in the opposite direction it is comparatively high. The entire action is electronic in nature as there is a flow of electrons from the copper into the oxide corresponding to a current flow in the opposite direction. When the polarity through the rectifier is reversed the electron flow practically ceases, thus producing a negligible reverse current.

At the time of preparing the non-porous oxide, preferably to the smoother side of the copper disc, there is usually formed a very thin layer of cupric (black) oxide on the surface of the cuprous oxide, the desired layer. While its removal may be effected by emery

cloth or nitric acid, such a procedure may not be essential as rectification is thought to be due to the intimate contact of cuprous oxide and copper. Other investigators contend that the cupric form possesses a higher resistance than the cuprous oxide and should, therefore, be removed, preferably by acid, which treatment etches the crystals, decreases the conductance in both the high resistance and forward directions, and thus improves the rectification ratio. In any case, the resistance constants of the de-

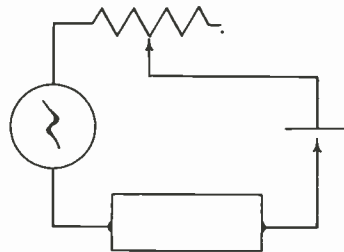

Fig. 2. In a half-wave circuit the rectifier changes that portion of the a-c wave which is in agreement with its direction of rectification.

vice do not appear to change materially with variations in the thickness of the conductive compounds employed, thus indicating a dependence upon the nature of the layer at the junction between the metal and its closeness to the compound.

CHARACTERISTICS

The ohm-volt-ampere relation¹ for a single copper-copper oxide disc is shown in Fig. 1. When a series of such washers, oxidized to yield the desired molecular relation between the copper and oxide at the junction, are clamped on an insulated rod along with various washers to effect connections, radiation fins, and more uniform pressures, rectifying efficiencies as high as 70 percent can be obtained in usual practice. In general, very high frequencies can be rectified, although some capacitance effect is then said to be encountered. Theoretically, a large number of units can be assembled into rectifiers of any

desired rating, the maximum space being a cubic foot to every 4 kilowatts and of weight equal to twenty pounds per kilowatt. Of the commercial sizes manufactured at present trickle chargers have a 13 to 6-watt output ($\frac{1}{2}$ to 1 ampere at 6 volts) while railway signal rectifiers are constructed that have a 200-watt output. In applications where high current and small size are essential requirements, the so-called dry disc rectifiers furnish a watt output per cubic inch four to five times that of other types, thus making possible considerable reduction in size.

Since the junctions are readily damaged by overheating, in extreme cases causing the contact foil to melt, and deterioration is promoted by thermal expansion, it is advisable to keep the operating temperatures below 60° C. or as low as possible. In general, the limit to current-carrying capacity depends on the provision for radiating the developed rectifier heat. A current density of 0.07 ampere per sq cm may be considered normal when no special ventilation is provided, while under conditions of forced ventilation, by the use of extra large fins, the density can be raised to 0.6 ampere per sq cm without undue heating.

Disc size varies from 1½-inch diameter for low-impedance values, to ¾-inch diameter for medium and higher impedances. The assembly of these rectifiers is carried out in such a manner that the

¹Grondahl, Trans. A. I. E. E., 357, 1927.

Fig. 3. Full-wave rectification with a reactance in the load circuit results in a steady output current.

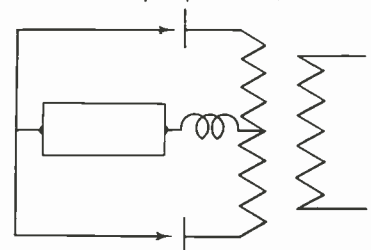

RECTIFIERS

by Bernard H. Porter

number of discs is sufficient to withstand the alternating-current voltage necessary to produce the required direct-current voltage, and the number of parallel groups will carry the necessary direct current, each unit being designed for half- or full-wave rectification.

A circuit with four junctions of the usual size will supply a rectified potential of 3 to 6 volts and an output current of 0.125 to 3.5 amperes, depending on the area of the exposed radiating surface of the discs, the cell-life anticipated, and the care taken in the cooling of the units.

The most efficient rectifier operation is obtainable only under the proper pressures applied to the discs, it having been found that within certain limits an increase of pressure causes an increase of the rectification ratio.

CIRCUITS

Rectifier circuits may be divided into two types, the high- and the low-powered hookups, depending on the amount of power to be rectified. Low-powered circuits, and brief notes thereon, are given in Figs. 2 to 4, inclusive.

MANUFACTURE

For the fabrication of the copper-oxide type of uni-directional current-carrying device, described above, certain techniques have been found desirable.

Fig. 4. The "bridge" circuit materially reduces the reverse potential applied to the rectifier units.

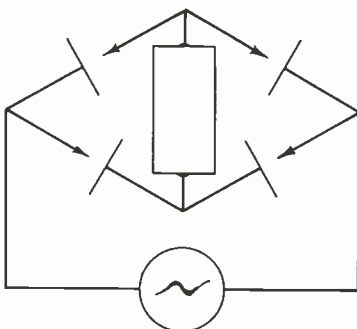

NOVEMBER, 1936

For example, it has been noted that the characteristics of the rectifier can be varied by changing the heat treatment given to the discs after oxidation. In general, high resistance values are obtained by slow cooling in air, while lower resistance results from rapid cooling or quenching. Values within these limits, obviously, are effected by appropriate cooling means.

Copper oxide melts at approximately 1025° C. and the rectifier discs are usually oxidized at a temperature of

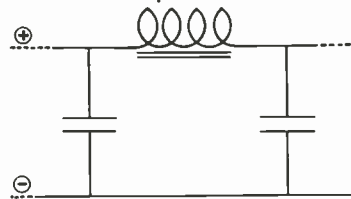

Fig. 5. A rectifier supplies plate and filament voltages through this typical filter or noise-suppressing circuit.

some 1040° C. At this temperature the oxide is formed not only on the copper, but also from the copper as well. In fact, such a degree of intimacy is attained that when the treated disc is distorted the cuprous oxide crystals usually crack within themselves rather than break away from the copper.

In order to provide better contact between copper-oxide discs as they are mounted under pressure on a common bolt, metal foils or lead washers may be employed between the oxide layer and the metal area of two adjacent discs. Alternate procedures achieve the same result by sputtering a metal deposit directly to the oxide or by providing good electrical contact with the cuprous oxide by any similar means. Tin is non-reactive with cuprous oxide.

Current practice recognizes the advantages of a colloidal graphite deposit for this purpose, the fineness of its particle size, the tenacious manner in which it adheres, and the possibility of building up comparatively thick films, being

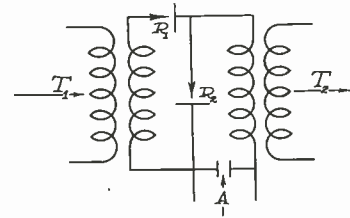

Fig. 6. An unbalanced, variable attenuation network.

especially useful. Colloidal graphite is chemically inert. At the time of coating the discs with an aqueous suspension of graphite by means of a camel's-hair brush, care is taken to keep the coated portion about one-sixteenth of an inch from the edge. A series of air jets play from both the coating and testing turntables upon the coated discs to hasten drying prior to testing. Each disc must be capable of conducting currents in the order of seven to ten amperes, before passing to the assembly tables.

RECENT APPLICATIONS

Apart from the use of rectifiers as power supplies for battery chargers, telephone and telegraph systems, and broadcasting transmitters, they are employed in noise-suppressing circuits and in variable-attenuator networks; as modulators in place of grid-voltage modulation by triodes; and finally, as the polarized-controls for relays.

Current supplies for telephone apparatus, audio repeaters, amplifiers, operators' speaking batteries, and the like, must be smooth and free from ripples, within the audio range; it is necessary, therefore, to install between the rectifier unit and the load, smoothing circuits or filters consisting of inductance in the form of a low-frequency choke and capacity in the form of bridging condensers. Fig. 5 shows a typical filter circuit or noise-suppressor used with a rectifier-supplying anode and filament voltage direct to a v-f repeater.

A variable-attenuation network, inserted in a-c signal circuits, is used effectively in conjunction with voice-operating switches, the loss being changed by a controlling direct-current applied to it. Such networks comprise either series or shunt rectifier units.

In the unbalanced network (Fig. 6), signal transformation is in the direction T_1 to T_2 , while the controlling current enters the circuit at A. When the current passes in the direction A, it will be applied to the rectifier R_1 , so that low
(Continued on page 13)

Page 9

RMA'S RECOMMENDATIONS ON ALLOCATION

As presented to the FCC by L. C. F. Horle

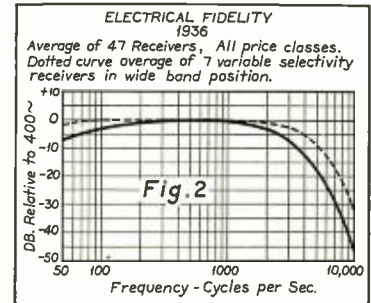
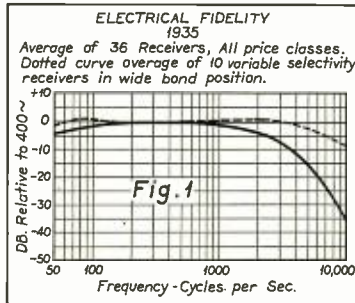

THE ENGINEERING DIVISION of the Radio Manufacturers Association is glad to have this opportunity of offering to the Federal Communications Commission such assistance as its experience and activities in the design of radio receiving equipment makes possible. It has been instructed by the Board of Directors of the Association to provide all available data of value to the Commission in this hearing and it here presents that data along with certain recommendations based not only on the data that is offered but on its general experiences in apparatus design and on its experience in the use of that apparatus in the field.

It is the feeling of the Engineering Division that the scope of its activities largely limits its possible assistance to the items concerning practicable standards of receiver fidelity and selectivity as enumerated in the agenda of this meeting in Docket No. 4063 and it is

to the gathering of data on these two points that its efforts have been directed. To this end, several of the research and development groups in its membership which are largely concerned with the technical problems of the industry were encouraged to gather this data, and the data so gathered has been analyzed and is here offered. It should be especially pointed out that the receiver characteristics here shown have been evolved largely under the influence of the two major factors of, first, the policies with respect to frequency assignment in force in the nation, and, second, the especial and characteristic economic limitations imposed on the design and production of equipment for general public use. In examining the data both these factors must be borne in mind, especially since it appears obvious to the Engineering Division that while continued evolution will doubtless bring continued improvement of receiver characteristics, no improvement of major importance can be confidently expected at once except at prohibitive cost and because, also, while only relatively minor modifications in frequency assignment practices may be expected to provide rather important improvements in broadcasting reception as will be later suggested, major changes in assignment practices might seriously and adversely affect it.

In general, the data here discussed falls into two categories. The first concerns itself with the selectivity and fidelity of receivers as commonly defined and, in fact, comprises the results of measurements made on a host of receivers manufactured during the last three years from which measurements the Engineering Division believes the Commission can make useful deductions as to receiver performance in the field of value in the solution of some of the problems which it faces in the allocation and assignment of frequencies to broadcasting.

Additionally, and after most careful consideration of certain other limitations resident in receiver design other specific data has been gathered and is offered to the Commission along with recommendations as to its possible influence in the solution of interference problems.

As to the former of these, the data gathered is shown in Figs. 1 to 11 of the attached curves. These give the average fidelity of a total of 83 different receivers of which the average fidelity

of the 36 models built during 1935 is shown in Fig. 1 and the average fidelity of the 47 models built during 1936 are shown in Fig. 2. As is probably well understood, a considerable portion of the productions of both these years included receivers in which the selectivity and hence the fidelity was controllable by the user. This fact has been here given weight by the inclusion in the data of the characteristics of these variable fidelity types of receivers. Thus, in Fig. 1 is shown also the average fidelity of ten 1935 models of variable fidelity and of seven 1936 models of variable fidelity with the variable fidelity control in the "wide-band" position. In the case of the receivers whose characteristics are shown in Figs. 1 and 2, the correlation between price and fidelity was not sufficiently well marked to justify any differentiation on a price basis.

It should, perhaps, be here briefly

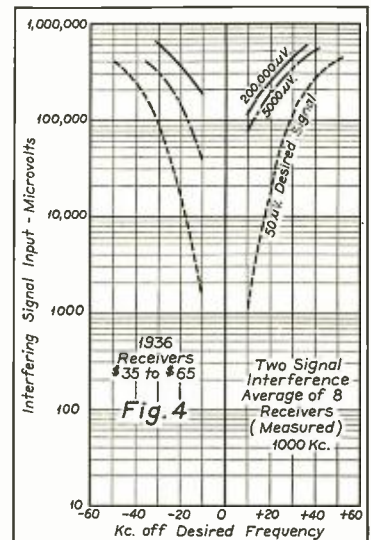
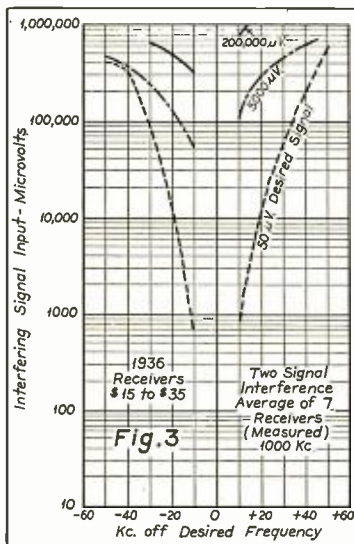

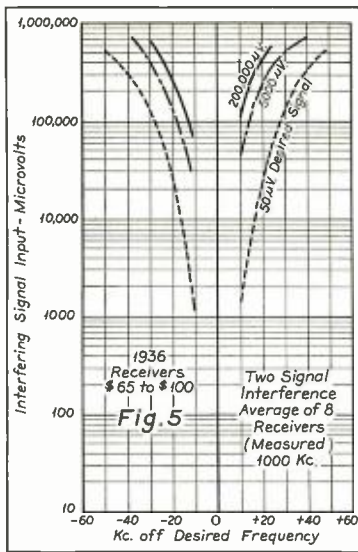

cast frequency assignments and that, unless and until the general noise level is markedly lowered or the general power level of broadcasting is markedly raised or some not now commonly used alternate system of broadcasting of such a nature as to provide more satisfactorily against noise interference, comes into general use, no markedly closer approach to truly high fidelity than that shown in the curves is practicable.

In Figs. 3 to 11 herewith, are given the interference characteristics of 43 different radio receivers built in 1934, 1935 and 1936. The data there shown differs markedly from the selectivity curves as commonly given in describing receiver performance characteristics. These are usually made by tracing the receiver characteristics when the receiver is excited by a conventional signal generator and while they provide much useful information as to what may

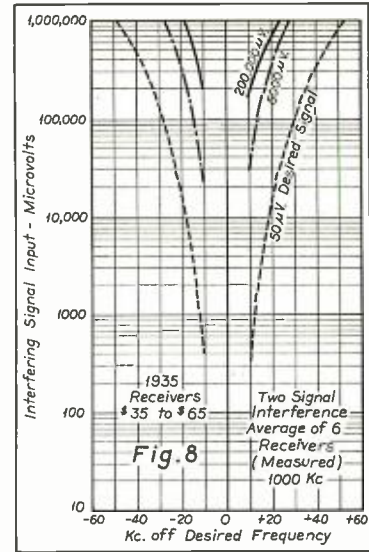

pointed out that the method and equipment used in the gathering of this data were those prescribed under "Standard Tests of Broadcast Receivers" in the "Report of the Standards Committee," 1933, of the Institute of Radio Engineers.

With respect to this data it is important to note that this represents the best compromise which the designers and manufacturers of radio receivers have been able to make between the truly faithful reproduction which is desired by all concerned and the limitations imposed thereon by the frequency assignment separation of 10 kc and by radio noise. Experience has shown that any expansion of the acceptance band width of broadcast radio receivers would make performance distinctly less suitable under the conditions of operation now in effect within the pattern of our broad-

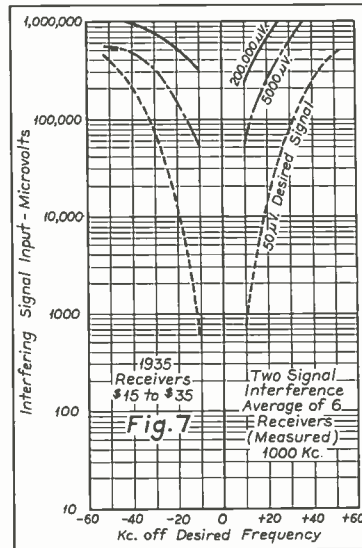

preted as a lack of interest in the characteristics of this low-price type of equipment.

In addition to the purely technical data given in Figs. 3 to 11, effort has been directed toward the gathering of available information as to the comparative distribution of these several grades of receivers in the hands of listeners. Based on data provided by the U. S. Department of Commerce, the following estimated distribution has been formulated:

Year	Total Units	\$15 to \$35	\$35 to \$65	\$65 to \$100	\$100 Up
1934.....	4,556,000	34%	52%	11%	3%
1935.....	6,026,000	32%	52%	13%	3%
1936.....	6,000,000 (est.)				

The Engineering Division does not feel that its limited experience and familiarity with allocation and frequency assignment problems provide sufficient basis for the interpretation of the data

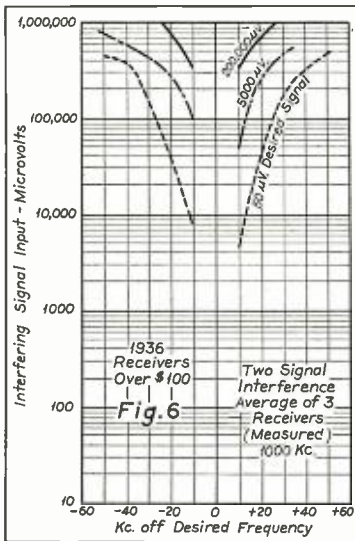

be expected of the receiver under operating conditions, they do not specifically show what may be expected from the receiver when operating under conditions of severe interference. For this purpose the so-called "two signal generator method" is necessary and has, in fact, been used in gathering the data here given. Both the equipment and method were those prescribed in "Standard Tests of Broadcast Receivers" in the "Report of the Standards Committee," 1933, of the Institute of Radio Engineers.

Where classification of the data on a price basis has been made, the retail price as advertised and at which the receivers were, in general, sold to the public is given. No data with respect to receivers selling for less than fifteen dollars is given. The Engineering Division does not wish this to be inter-

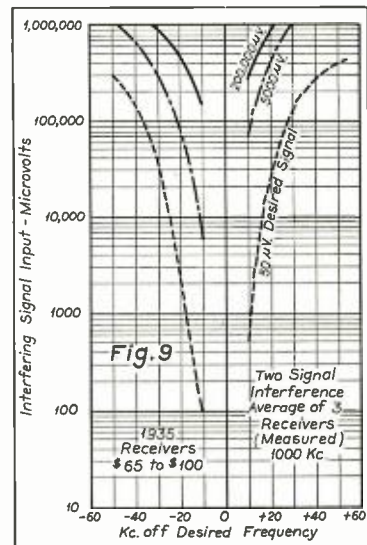

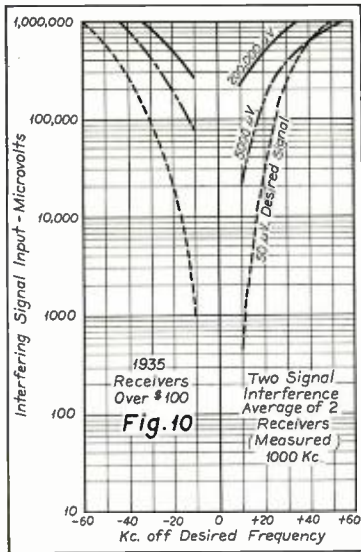

given in terms of suggested rules or regulations. For this reason and because, also, others who have had access to this data will doubtless make specific interpretations thereof and recommendations thereon, it prefers merely to offer it to the Commission.

It does, however, wish to emphasize the fact that in presenting this interference data it by no means presents a complete analysis of interference possibilities and limitations. Certain of these others will be discussed in a following section of this report, but it should be here emphasized that the attention of the industry is being increasingly called to interference which in no way involves receiver characteristics and against which the receiver provides no shield. Only two of these need be here mentioned: of these the cross modulation of transmitters due to their close proximity to one another while not common is giving rise to serious difficulty in at least one area. A second of these interferences, and one not resident in either transmitter or receiver is that which is coming to light in a number of widely separated sections of the country and appears, at this writing, to reside in the nonlinear conduction of certain metallic structures—such as power lines, their supporting cables and the like—which, when subjected to strong signal fields provide cross modulation which later finds its way to a receiving set and gives all the evidence of receiver failure. No data can, as yet, be given as to these except to point out that the potential presence of these sources of interference provides a new and perhaps serious hazard to the continued improvement of radio broadcasting.

The Engineering Division wishes to present other data to the Commission for its consideration, data which, how-

ever, does not lend itself to such concise presentation as that already offered. This is concerned with the fact that during the last six years substantially all other types of radio receiver circuit arrangements have been abandoned in favor of the superheterodyne type of receiver and because of this fact, along with the development of highly effective vacuum tubes and the standardization that has been made possible by these changes, the performance characteristics of radio receivers have been greatly improved while costs and selling prices have been greatly reduced. At this time, there appears to be no evident reason why the superheterodyne circuit will not continue to be the predominating circuit arrangement in the broadcast receiver field and that, therefore, certain inherent characteristics of this type of circuit of significance in connection with the matter of this hearing should be here brought out.

More specifically, the technical and economic advantages of the superheterodyne receiver lie largely in the fact that the major portion of the sensitivity and selectivity of the receiver may, by design, be supplied by the non-tunable, fixed frequency portion of the high frequency amplifier of the receiver and thus, because of the lack of need for variability of the frequency at which this portion of the receiver—the intermediate frequency amplifier—operates, the desired degree of amplification and selectivity may be, and, in practice, is secured with maximum economy, stability and reliability. This, however, is accompanied by the fact that the superheterodyne receiver is inherently sensitive to signals the frequencies of which approximate that at which the intermediate frequency amplifier operates, and, additionally, to signals the sum or difference or multiples of the frequencies of which approximate some multiple of the i-f frequency. Thus, in any practical superheterodyne radio receiver it is the

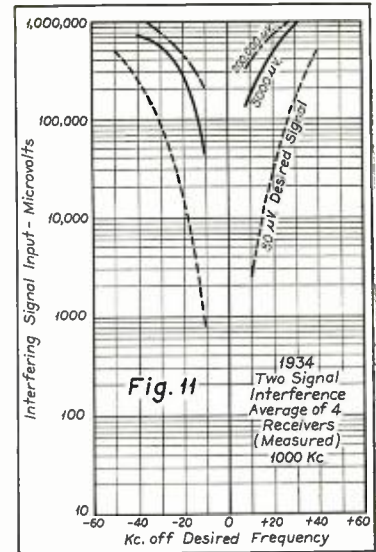

function of the tunable radio frequency amplifier which precedes the non-adjustable intermediate-frequency amplifier in the circuit arrangement, to provide selectivity against the interference which would otherwise result from the several sensitivities of the i-f amplifier. In general, and against most of the numerous possible interferences here resident, satisfactory protection has been provided notwithstanding the severe economic limitations imposed on practical receiver design in recent years. There are, however, several of these potential sources of interference which occasionally and under adverse conditions give rise to interferences that are sufficiently serious to justify discussion and, it is hoped, some action tending toward their elimination. These are:

Type 1. The interference produced by the operation of radio transmitters in close proximity to broadcast receivers at frequencies approximating the frequency of operation of the i-f amplifier of the receiver.

I.F. RESPONSE RATIO, AVERAGES									
Data is given under each I.F. category from measurements with the receiver tuned to each of three test frequencies, 600 Kc., 1000 Kc., and 1400 Kc.									
2-Gang									
I.F.-----600-----			350-480-----				-----1400-----		
No. of Cases	4		7			2			
Max. Ratio	92.1		750			81			
Min. Ratio	10		17			47			
Ave. Ratio	34.8		143			64			
3-Gang									
I.F.-----175-200-----			200-350-----				350-480-----		
No. of Cases	3	9	2	2	5	11	15	7	
Max. Ratio	17,200	90,000	31,000	11,100	75,500	13,300	23,000	15,800	
Min. Ratio	4,600	15,000	30,000	960	875	69	840	805	
Ave. Ratio	11,267	52,944	30,500	6,030	27,361	2,502	6,076	6,259	
Average I.F. response ratio 2-gang condenser all frequencies = 98									
" " " 3-gang " " " = 16,345									

Type 2. Interference produced by the operation of two or more transmitters in close proximity to broadcast receivers at frequencies which differ from one another by an amount approximating the frequency of operation of the i-f amplifier of the receiver.

Type 3. Interference produced by the operation of transmitters in close proximity to broadcast receivers at frequencies closely approximating a multiple of the frequency of operation of the i-f amplifier.

Of these, the more serious seems to be Type 1, that is, the interference produced by the operation of radio transmitters in close proximity to broadcast receivers at frequencies approximating the frequency of operation of the i-f amplifier. This has shown itself to be particularly troublesome both on the east and west coasts and along the Great Lakes as a result of the operations both of fixed and mobile transmitters at frequencies between 440 and 480 kc.

For such use as it may have for the Commission in evaluating the continued possibility of this type of interference, the protection against it provided by typical receivers has been measured and is given in the table of I-F Response Ratio Averages.

The second of these types of interfer-

ence, i. e., that produced by the operation of two transmitters in close proximity to broadcast receivers, the frequencies of operation of the transmitters differing by an amount approximating the frequency of operation of the i-f amplifier must also be considered.

Serious difficulty from this type of interference is experienced at widely separated points throughout the country and shows itself to be especially objectionable in that listeners in areas where two powerful stations so related to one another in frequency receive the resultant beat or whistle along with the signals of any station to which they may be listening.

Additionally, there is the third type of interference, i. e., the interference which results from the operation of a transmitter in close proximity to broadcast receivers at a frequency approximating twice the frequency of the i-f amplifier. Little or no protection against this type of interference can be provided through the conventional methods of preselection before i-f amplification since the resultant beat or whistle—or more commonly, the second harmonic “tweet”—is as yet, the largely unavoidable concomitant of the essential non-linearity of detector or mixer tubes.

With respect to these several types of interference it can be reported that for

the last six years the industry has been attempting to meet these difficulties by numerous expedients, differing with the type of interference, the territory in which it occurs and such other factors as provided possible methods for its reduction. It is probably without point to here enumerate the range of expedients that have been thus developed in attempting to meet this problem, but it should, of course, be pointed out that the choice of the i-f frequency has been the basic means available for its solution. No single i-f frequency has provided freedom from interference in all areas and, indeed, no single expedient has provided any generally satisfactory solution.

It is most important to note, however, that the solution to these interference problems has in almost every case required the further and further departure from the very standardized production that has made high quality radio reception economically possible.

It is hoped that this brief reference to the problem will result in an intensive search for a more general solution. The complete solution doubtless lies in the coordinated action of the Radio Manufacturers, the Commission, and such others as are concerned with the problem for the purpose of providing a protected i-f frequency.

JUNCTION RECTIFIERS

(Continued from page 9)

impedance of the rectifier to both alternating and direct current results. Simultaneously, it will be applied to R_2 , in the reverse direction, so that the impedance is high. Hence the attenuation between transformers T_1 and T_2 is small in the signal-transmission circuit. Conversely, if the direction of the control current is reversed, the impedance at R_1 increases while that of R_2 decreases, to produce high attenuation between T_1 and T_2 .

In the balanced network, where the rectifiers are shunted, impulses of the control current do not pass into the signal circuit. Inductances of the transformer windings, therefore, are not varied and do not prevent a rapid change of the control currents. These variable networks are used in valveless differential echo-suppressors.²

In place of the usual grid-voltage modulation of the triode valve, four groups of rectifiers can be so arranged that, while speech energy is applied to double-balanced groups symmetrically, the carrier's oscillator-supply is applied differentially, and modulation results.

Finally, rectifiers can be connected to the ordinary telephone relay to permit

decisive operation on low-frequency ringing current. An ordinary copper-slugged relay is shunted by a small rectifier unit, the relay being adjusted to operate on small values of ringing current without chatter. Polarized control by direct current of one or two relays on the same circuit, spark-quench circuits, and remote control of ac-dc supply also employ the rectifier in relay working.

FLAT TYPE RECTIFIER

The necessity for producing heavy-output units with a minimum of mounting space has resulted in a rectifier element consisting of a single plate about 11 inches long by 3 inches wide.³ Its entire surface is active. Actually these units have less effective radiating properties as compared with the disc-fin type at ordinary ventilation, by reason of the large cuprous-oxide surface which is entirely covered with metal paint; yet their usefulness is due to the construction methods whereby forced draft can be used between the units which are mounted with the individual plates arranged on edge vertically. Economy in

mounting space is possible in large assemblies with this type.

COPPER-SULPHIDE RECTIFIERS

The mechanical construction of a rectifying unit using magnesium and cupric sulphide washers is identical with that of the copper-oxide form. While no film-forming action is required for the device just described, apart from the oxidizing treatment of the discs, it is felt that a film which later provides the rectifying action of the magnesium, copper-sulphide type, is formed at their junctions by the initial passage of current. The inverse current is said to be one seventy-fifth of the useful current, corresponding to resistances per unit of 30 ohms and 0.4 ohm in two directions. Four volts is given as the safe operating potential per junction in this design, the maximum temperature to be attained without injury is 150° C., and reputed life is in the order of thousands of hours, provided the units are not left idle in a moist atmosphere. After minor accidents the film between the cupric sulphide and magnesium is said to be self-healing. The present commercial sizes are from 0.2 to 3 amperes and 2 to 50 volts using the “bridge” circuit with a varying number of junctions.

²“Recent Developments in Telephone Transmission,” L. E. Ryall, page 155. Post Office Elect. Eng. Journ., April, 1935.

³Elect. Eng. and Merchandiser, Nov. 15, 1935, page 273.

FREQUENCY-MODULATED GENERATORS

The subject of frequency modulation has been discussed in great detail, both pro and con, since its announcement by Major Armstrong. Here it is boiled down and applied to signal generators.

by A. W. Barber*

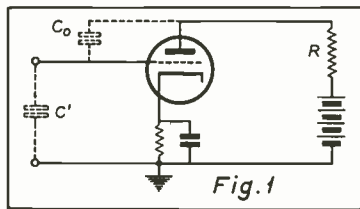

Fig. 1

DESPITE SOME ATTEMPTS to show mathematical equivalence between frequency and amplitude modulated waves, it is far simpler to deal with them as distinct types. A radio-frequency wave of frequency f_h modulated in amplitude at a rate f_1 consists of a carrier of frequency f_h and two discrete sidebands having the frequencies $f_h + f_1$ and $f_h - f_1$. While this same wave of frequency f_h frequency modulated at a rate f_1 may be expressed mathematically as a carrier of frequency f_h and a series of discrete side frequencies above and below f_h spaced f_1 apart, for the discussion at hand we may merely think of a wave continuously varying in frequency above and below a mean frequency f_h and repeating each cycle of variation f_1 times per second.

In an oscillating circuit frequency

*Consulting Engineer.

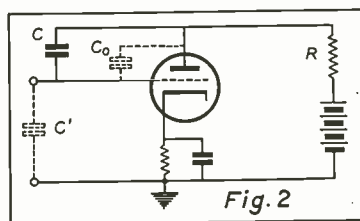

Fig. 2

modulation may be produced by varying any one of the three circuit elements—capacity, inductance or resistance. These elements may be varied either by mechanical or electrical means. For producing pure frequency modulation capacity or inductance variations are preferred since, in general, a resistance variation produces a much larger amount of amplitude modulation for a given percentage of frequency modulation. Mechanical methods of producing frequency modulation involving motor-driven condensers, eddy current driven inductance varying vanes and similar devices have been used. Aside from the fact that they are mechanical these systems are quite satisfactory for cases where a small fixed amount of frequency variation at a fixed rate of variation is desired. On the other hand, electrically varied circuit elements offer possibilities of great flexibility and at the same time permit more compact and cheaper circuits.

Of all the now known methods of circuit variation the electronic variable capacity is the most promising. This paper will deal with general considerations in the design of electronic variable capacities, their application to frequency-modulated signal generators and a special application in a constant bandwidth modulator tunable over a range of frequencies. The systems to be described depend on the operation of a thermionic amplifier having current fed back from its output to its input circuit in such a phase as to produce an equivalent dynamic input capacity greater than its static input capacity.

In its simplest form an electronically-

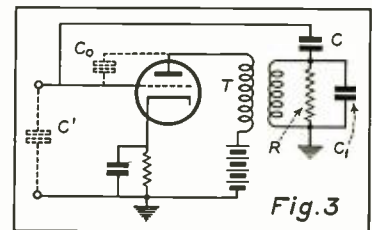

Fig. 3

controlled capacity consists of the effective input capacity of a thermionic vacuum tube having a resistive plate load. The capacity between input and output is augmented by the amplification of the tube. This capacity in the simple case is supplied by the plate-to-grid capacity of the tube itself and any stray capacities across it such as socket and wiring capacities. Fig. 1 shows this type of capacity in which R is the plate load resistor, C_0 represents the tube and stray capacities between plate and grid and C' represents the dynamic input capacity to the tube. The effective input capacity may be increased by adding an external capacitor C between plate and grid as shown in Fig. 2. Since R must be kept small in order not to have too great a loss component in the effective

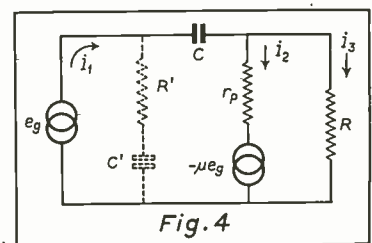

Fig. 4

capacity, a greater voltage may be generated across R by coupling it to the tube plate by means of a step-down transformer T as shown in Fig. 3. It is desirable to have the coupling between primary and secondary of transformer T as tight as possible in order not to shift the phase of the voltage across R, but in case the coupling is deficient, a phase correcting condenser C₁ may be placed across R. The polarity of transformer T should be such that the high end of resistor R has the same phase as the plate of the tube.

Mathematically the circuits shown may be analyzed by means of the equivalent circuit shown in Fig. 4.

We may write by Kirchhoff's law:

$$e_x = \frac{-j i_i}{C\omega} + r_{p1} i_a - \mu e_c \dots (1)$$

$$e_x = \frac{-j i_i}{C\omega} + R i_a \dots (2)$$

$$i_i = i_a + i_s \dots (3)$$

Solving these for the effective impedance across e_x we obtain:

$$\frac{e_x}{i_i} = Z' = \frac{R - j \left(\frac{1}{C\omega} + \frac{R}{r_p C\omega} \right)}{1 + \frac{R}{r_p} (1 + \mu)} \quad (4)$$

Thus Z' is a complex quantity indicating that the effective impedance of the input circuit of the electronic capacity tube has a resistive and a reactive component. Calling the effective input reactance X and the effective resistance in series with it R', we have:

$$R' = \frac{r_p R}{r_p + R + \mu R} \dots (5)$$

and

$$X = \frac{-j \left(\frac{1}{C\omega} + \frac{R}{r_p C\omega} \right)}{1 + \frac{R}{r_p} + \frac{\mu R}{r_p}} \quad (6)$$

We note that the reactive component is negative and hence represents a capacity. Calling this capacity C', we have:

$$C' = \left[1 + \frac{\mu R}{r_p + R} \right] C \dots (7)$$

ΔG_m	C'	Δf	Q
0.001	1000 Mmfd.	10,000 Cycles	8
0.002	1000 "	10,000 "	16
0.003	1000 "	10,000 "	24
0.005	1000 "	10,000 "	40
0.001	100 "	10,000 "	80
0.002	100 "	10,000 "	160
0.001	100 "	100,000 "	8
0.005	100 "	100,000 "	40
0.005	10 "	1,000,000 "	40

Fig. 6

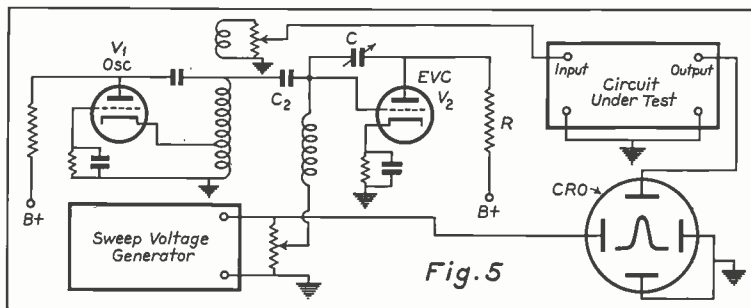

Fig. 5

If $1 \ll \mu$ and $g_m =$ mutual conductance we may write:

$$R' = \frac{R}{1 + R g_m} \text{ (approx.)} \dots (8)$$

Where $R \ll r_p$, $R g_m =$ gain, and hence:

$$R' = \frac{R}{1 + \text{gain}} \dots (9)$$

and

$$C' = [1 + \text{gain}] C \dots (10)$$

Thus both the effective input capacity and resistance of a vacuum tube may be varied by varying the tube gain. The gain and hence the effective input capacity of the tube may be controlled by varying the tube load resistor, plate voltage or grid voltage. A convenient method of capacity control is to choose R for the maximum desired capacity change and to vary the grid potential periodically thereby determining the rate at which the capacity is varied. This readily controlled capacity forms a convenient circuit element whereby the frequency of an oscillator may be controlled.

A frequency-modulated signal has many unique uses. Perhaps the most important use is in measuring the response of tuned radio- or intermediate-frequency amplifiers. It is particularly useful in aligning three circuit interstage couplers and expanding selectors. By beating the frequency modulated wave with a fixed frequency wave a swept audio note is produced which is valuable in investigating the response of audio amplifiers and filters.

Fig. 5 shows a typical circuit for testing with a frequency-modulated wave generated by means of an electronically-controlled capacity. Equation (10) above states that $C' = (1 + \text{gain}) C$ and hence C' may be varied by varying the gain of the capacity control tube. In Fig. 5 tube V₂ is the capacity control tube and its gain is varied by applying a control voltage to its grid through the choke L₂. If then the grid-to-cathode impedance of tube V₂ is placed in shunt with the inductance L₁ of oscillator V₁ by means of the coupling condenser C₂, the frequency of oscillator V₁ may be

controlled by means of the grid potential variation of V₂. If a portion of the voltage generated by the "sweep voltage generator" is used to control the oscillator frequency and this same sweep voltage is applied to the horizontal deflecting plates of a cathode-ray tube "CRO," the frequency of oscillator V₁ will be a function of the beam position of the cathode-ray tube. If then a circuit or amplifier is investigated by feeding its input with a voltage from oscillator V₁ and applying its output to the vertical plates of the cathode-ray tube, a completely synchronized trace of the circuit response will be obtained on the screen.

Since there is a resistive component in the input impedance of the capacity control tube, practical circuit design must take it into account. A convenient method of expressing the effect of the input resistance is in terms of the Q of the input capacity.

$$Q = \frac{1}{R' C' \omega} \dots (11)$$

$$\text{since } \omega = 2\pi f \text{ and } f = \frac{2 C' \Delta f}{\Delta C'}$$

where $\Delta C'$ is the change in C' due to the change in gain of the capacity control tube and Δf is the produced frequency change.

$$Q = \frac{\Delta C'}{4\pi R' C' \omega \Delta f} \dots (12)$$

now

$$\Delta C' = C' \times \text{gain} = C' R g_m$$

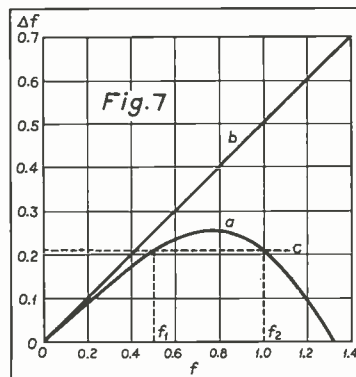
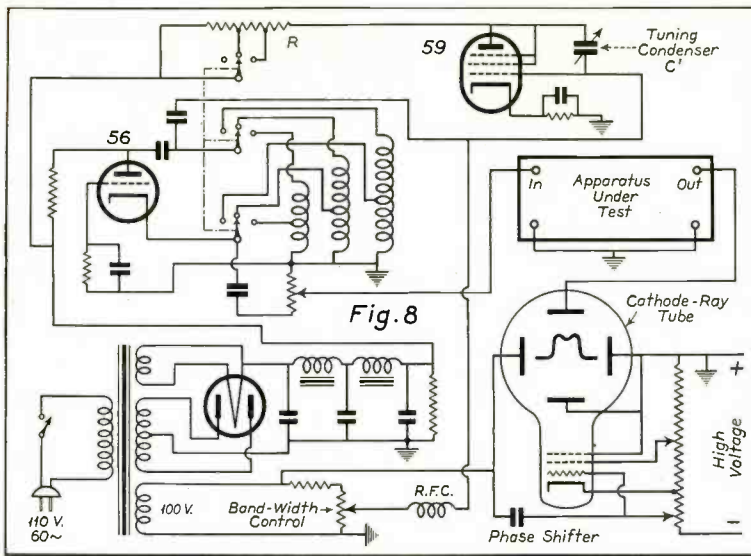

Fig. 7



5.25C₃ to cover the two-to-one range of carrier frequencies. In a signal generator with range switching the frequency modulation bandwidth may be adjusted to the same or any other desired width for each range by changing resistor R for each range.

Fig. 8 shows a complete circuit diagram of a multi-range frequency-modulated signal generator. A type 56 tube is shown as an oscillator associated with a coil changing switch. A type 59 tube is used as an electronic variable capacity frequency modulator. The oscillator tuning condenser is connected between plate and grid of the modulator. The bandwidth determining resistor R is switched at the same time that the range is changed. The modulator is driven from the 60-cycle source and the bandwidth of modulation is controlled by a potentiometer feeding the grid of the modulator through a radio-frequency choke. The horizontal axis of the cathode-ray tube is also supplied with voltage from the 60-cycle source. By applying the 60-cycle voltage to the grid of the cathode-ray tube through a small condenser, which acts with the grid bias potentiometer to shift the phase, one of the horizontal traces may be eliminated.

One distinct advantage of using a 60-cycle sweep frequency has been found. Any hum voltages present in the system being tested are synchronized with the cathode-ray tube pattern and do not cause the flicker which may be present when other frequencies of sweep are used.

Fig. 9 shows curves of capacity or frequency change against change in mutual conductance of the electronically-controlled capacity tube for various values of plate load resistor R. The change in mutual conductance is the change caused by the sweep voltage applied to the tube grid.

and

$$R' = \frac{R}{1 + \text{gain}} = \frac{R}{1 + R G_m}$$

hence

$$Q = \frac{G_m + R G_m^2}{4\pi C' \Delta f} \dots \dots \dots (13)$$

In general

$$G_m^2 R \ll G_m$$

and hence

$$Q = \frac{G_m}{4\pi C' \Delta f} \dots \dots \dots (14)$$

The table in Fig. 6 shows various values of Q obtained for various values of G_m, C' and Δf.

In the design of a particular system the relation $R = \frac{2\Delta f}{G_m f}$ may be used to

determine R when f is known by using the values shown in Fig. 6. This table shows the desirability of using a tube having a high G_m for the capacity control tube in order to keep the losses low. Amplitude modulation will be low if the losses in the electronic variable capacity do not change the combined coil and condenser circuit Q greatly.

In any practical oscillator system there will be a certain amount of unmodulated capacity such as coil distributed capacity, tube grid-to-cathode static capacity and stray wiring capacities. These stray capacities will reduce the frequency modulation excursion since:

$$\frac{\Delta f}{f} = \frac{\Delta C'}{2(C' + C_s)} \dots \dots \dots (15)$$

where C_s represents the stray capacity.

Since a frequency modulated signal is useful in radio receiver alignment, it would be useful to have a circuit producing a constant frequency modulation excursion or bandwidth as the mean frequency is varied. This may be accomplished if the circuit variable tun-

ing condenser is connected between the grid and plate of the electronic capacity control tube as shown in Fig. 5. Applying equation (15) it may be seen that as C' is varied both f and Δf are varied. Fig. 7 shows a plot of the relation between Δf and f as C' is varied as curve "a." Curve "b" shows the relation between Δf and f with C_s zero. Horizontal line "c" has been drawn intersecting "a" at f₁ and f₂ so that f₂ = 2f₁. As can be seen curve "a" over this two-to-one frequency range f changes less than 10 percent from a constant value. Thus f₂ may be chosen as the maximum frequency of the oscillator with the condenser at a minimum. At f₂ the effective minimum value of C' which includes wiring and static tube plate-to-grid capacity should be equal to 0.75C_s. The maximum value of C' to give f₁ should be 6.0C_s. Thus the change in capacity of C' should be

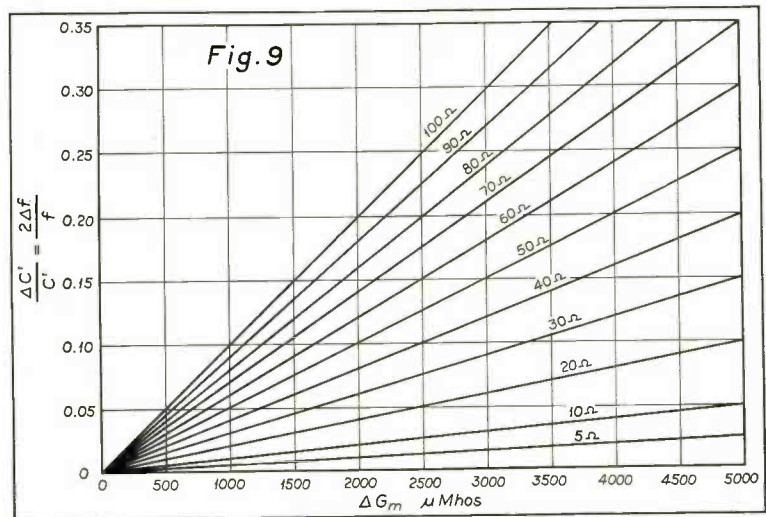



600 FEET FROM SUNLIGHT

To insure uninterrupted production as well as maximum safety, mine operators depend on SYNTHANE laminated bakelite for insulating mining machinery.

SYNTHANE—the dependable insulation that protects equipment in the air, on the ground, under the ground, on and under water—adds to your products the same degree of reliability.

SYNTHANE LAMINATED BAKELITE
SHEETS • RODS • TUBES
FABRICATED PARTS

Send for Sample Book



SYNTHANE

CORPORATION



OAKS • PENNA

ACOUSTICAL LEVELS

Various Noises and Orchestral Effects	Sound Pressure	Particle Velocity	Movement of Air	Sound Intensities	Power Level
	Dynes per Sq. Cm.	Cm. per Sec.	Millimeters at 1,000 Cycles	Microwatts per Sq. Cm.	Deci- bels
Threshold	0.000204	0.0000050	2.22×10^{-8}	10^{-10}	0
	0.000363	0.0000089	3.95×10^{-8}	3.165×10^{-10}	5
	0.000645	0.0000158	7.00×10^{-8}	10^{-9}	10
	0.001146	0.0000281	1.25×10^{-7}	3.165×10^{-9}	15
Whisper 4' from source.....	0.00204	0.000050	2.22×10^{-7}	10^{-8}	20
	0.00363	0.000089	3.95×10^{-7}	3.165×10^{-8}	25
Soft Violin 12' from source....	0.00645	0.000158	7.00×10^{-7}	10^{-7}	30
	0.01146	0.000281	1.25×10^{-6}	3.165×10^{-7}	35
	0.0204	0.0005	2.22×10^{-6}	10^{-6}	40
	0.036	0.00089	3.95×10^{-6}	3.165×10^{-6}	45
Bell F4 160' from source.....	0.0645	0.00158	7.00×10^{-6}	10^{-5}	50
Ordinary Conversation 3' from source	0.1146	0.00281	1.25×10^{-5}	3.165×10^{-5}	55
	0.204	0.0050	2.22×10^{-5}	10^{-4}	60
	0.363	0.0089	3.95×10^{-5}	3.165×10^{-4}	65
Bell F2 160' from source.....	0.645	0.0158	7.00×10^{-5}	10^{-3}	70
	1.146	0.0281	1.25×10^{-4}	3.165×10^{-3}	75
Full Orchestra					
Bell F4 6' from source.....	2.04	0.15	2.22×10^{-4}	10^{-2}	80
	3.63	0.089	3.95×10^{-4}	3.165×10^{-2}	85
	6.45	0.158	7.00×10^{-4}	10^{-1}	90
	11.46	0.281	1.25×10^{-3}	0.3165	95
	20.4	0.5	2.22×10^{-3}	1.0	100
Bell F2 6' from source.....	36.3	0.89	3.95×10^{-3}	3.165	105
Thunder	64.5	1.58	7.00×10^{-3}	10.0	110
Hammer 2' from source	114.6	2.81	1.25×10^{-2}	31.65	115
	204	5.0	2.22×10^{-2}	100.00	120
	363	8.9	3.95×10^{-2}	316.5	125
Threshold of pain.....	645	15.8	7.00×10^{-2}	1,000	130

WEATHERPROOF WIRE • MAGNET WIRE • SERVICE ENTRANCE CABLE • CRESFLEX NON-METALLIC SHEATHED CABLE

FLEXIBLE CORDS • RADIO WIRES • LEAD ENCASED CABLES • PARKWAY CABLE • VARNISHED CAMBRIC • SIGNAL CABLE

CRESCENT CORD SETS

WITH PARTS—READY TO INSTALL

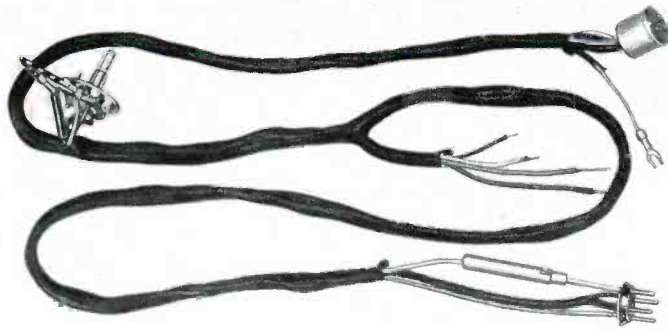

RADIO MANUFACTURERS

Make Big Savings with

CRESCENT COMPLETE CORD SETS

WRITE US—We will be glad to show you samples of work we are doing.

We are making large savings for radio manufacturers by assembling their cords complete with switches, sockets, fittings, etc.

We specialize in this work. Our testing and inspection is complete and we guarantee 100% perfect cords ready for installation. Send us your blue prints for prices on quantity production.

- RECEIVER CORDS
- ASSEMBLY CORDS
- ANTENNA CORDS
- SHIELDED CORDS



Address Department R.E.

CRESCENT
INSULATED WIRE & CABLE CO. INC.
TRENTON, NEW JERSEY

Announcing
2 entirely
NEW
TRANSFORMERS

by
FERRANTI

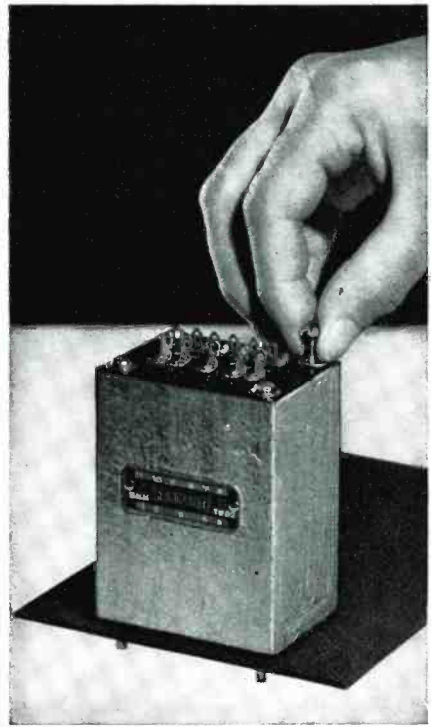

Series B $\approx 1/2$ db. 30 to 16,000 cycles
 Case $2\frac{3}{8}'' \times 1\frac{3}{8}'' \times 3\frac{1}{2}''$ h.
 Mntg. $2\frac{1}{8}'' \times 1\frac{3}{8}''$

Series A ≈ 1 db. 30 to 12,000 cycles
 Case $2\frac{3}{8}'' \times 2\frac{1}{8}'' \times 3''$ h.
 Mntg. $2\frac{1}{8}'' \times 1\frac{3}{8}''$

FEATURES . . .

1. 90 New Transformers in All
2. New Low Prices
3. New Designs Throughout
4. Latest High Fidelity Standards
5. New Self Shielding Core Type Construction
6. Free from Hum and Pickup
7. New Reversible Through-Type Mountings
8. No Waste Space for Mounting Flanges or Feet
9. Electrostatic Shields Between Windings
10. Small in Size
11. Light in Weight
12. Exceptionally Low Insertion Loss
13. Moisture-Proof Construction
14. Available for Immediate Shipment from Stock
15. Designed and Manufactured in the United States

The "A" Series is the lowest priced self-shielding transformer available . . . New straight-through mounting on both series, plus self-shielding enables units to be actually mounted against each other . . . no waste space . . . every unit designed for either top or subpanel mounting.

SEND FOR COMPLETE LISTING.

FERRANTI ELECTRIC, INC.

30 Rockefeller Plaza, New York, N. Y.



Mirror illustrates
 New Sub-Panel
 Mounting

SOME NOTES ON LUMINESCENCE

by Gilbert C. Schmidling*

THERE ARE SO MANY types of fluorescent and phosphorescent bodies that it has been found convenient to group all such phenomena under the general term "Luminescence." Although strictly speaking, hot bodies such as lamp filaments are luminescent, the former are distinguished by the fact that their light is radiated without noticeable rise in temperature.

There are many types of cold luminescence, for example,

Cathodo-luminescence, or that caused by cathode rays.

Photo-luminescence, or that caused by light whether visible or invisible and includes x-ray, ultra violet, and visible radiations.

Piezo-luminescence, or that caused by the pressure on crystals.

Crysto-luminescence, or that accompanying the formation of crystals.

Tribo-luminescence, or that caused by friction.

Lyo-luminescence, or the phenomena of light emission during chemical solution or precipitation.

Radio-luminescence, or that caused by radio active elements.

Thermo-luminescence, or that due to a sudden rise of temperature.

Bactero-luminescence, which refers to the light radiated by living bacteria.

About 12,000 of such materials and effects have been recorded. The various phenomena can be divided into living and non-living types and further subdivided by the terms fluorescence and phosphorescence. Each of the latter two are again sub-divided into organic and inorganic materials.

Although the luminescent materials were first mentioned by the several early Greek philosophers, Peter Cascariolus, a shoemaker of Bologna, is credited with having made the first synthetic material in 1602.

There have been so many hundreds of investigators in the three centuries since, that it is impossible and probably unnecessary to give a complete bibliography, but full credit is given to our predecessors and some references are appended.

*Electronics Dept., Callite Products Div., Eisler Elec. Corp.

There are grave discrepancies to be found in the literature in the findings of the various investigators, due, no doubt, to the difficulty in repeating the results of others. This is rather to be expected since no real key has yet been found by which one can predict the results of a new material. A large number of variables are encountered, such as the purity of materials, kind and amount of activator introduced, the working temperature, etc., all of which cause variations in results. It is, however, possible to duplicate a given material in manufacture.

There are many thousands of living animals which have the power to convert chemical energy directly into light; for example, the many types of fireflies of which there are approximately 25 species in the United States alone and characterized in the eastern parts of the country especially by the family Lampyridae. A specie Photinus Pyralis, was found by Ives and Coblenz to have an efficiency of 96.5 percent.

Many other light-giving animals inhabit the sea, earth and sky. The light from most types of fireflies seems to coincide with mating, but this is found to be no clue at all in investigating the various types. The New Zealand glow-worm, for instance, attaches itself to the ceiling of a dark cave and while glowing with a strong green light, proceeds to coat its long tongue with a sticky substance. It thus attracts and catches its prey. It is felt that the light given by living animals as a result of metabolistic processes within themselves belongs to the field of chemi-luminescence, since the radiation does not depend on adsorbed light.

All the organs of the human body are fluorescent, including the viscera, the veins, the bones, the skin, the hair, the teeth and eyes.

FLUORESCENCE AND PHOSPHORESCENCE

The terms fluorescence and phosphorescence are applied to those materials both organic and inorganic which radiate light when excited by light or other forms of energy. Usually the wave-

length of the radiated light is longer than the wavelength of the exciting light (Stokes Law), but there are many exceptions to this rule. Some compounds show a fluorescent band at a wavelength shorter than the exciting wavelength, but in these cases there is always a drop in the curve at the natural absorption points of the material.

The spectral band is divided into two parts, the fluorescent band easily being separated from the phosphorescent band.

The fluorescent band stops radiating apparently when the excitor is cut off, while the phosphorescent band is that which continues to glow for a time, the value ranging from the immeasurable to that of several days, and in some cases, weeks. They all show a property of thermo-luminescence in some degree. This property was first discovered in the fluorescent minerals which emit a flash of light on being heated the first time, after which the effect disappears and is readily demonstrable in most of the synthetic compounds. If a fluorescent compound is excited, by ultra-violet radiation, for example, only a part of the stored up energy will be emitted at room temperature. The remaining energy is held in some cases for many months; it can be expelled immediately by a sudden rise in temperature of several hundred degrees. This accounts for the thermo-luminescent minerals which are excited by radio-active energy in the earth.

The phosphorescent band can be quenched completely by immersing a sample in liquid air; radiation will begin on return to room temperature.

Some materials show the opposite effect, however, and a block of paraffin will glow with increasing brilliance as the temperature is lowered.

Another interesting property of fluorescent materials is the quenching of fluorescence by longer waves than the emitted light.

The total effect produced by the working of these two laws,

(a) The radiated light is of longer wavelength than the exciting light:

(b) The radiated light is quenched by longer wavelengths;

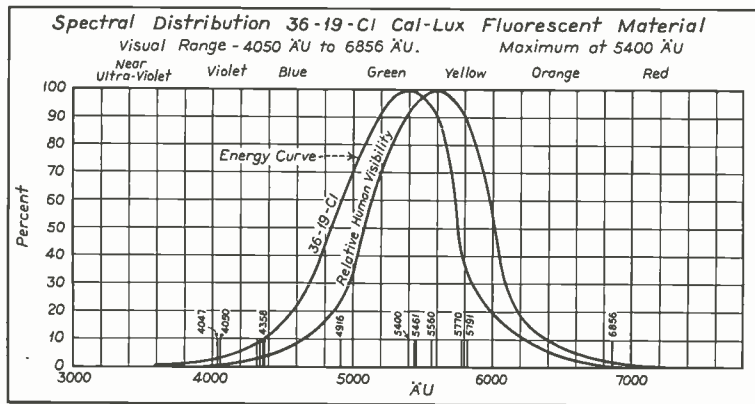

results in a highly complex phenomena. As a rule, the longer the wavelength, the longer the afterglow. The decay curves are never smooth and the decay occurs in steps.

These materials are true frequency transformers in that they convert light or other energy into radiation usually of some other frequency with only a slight decrease in the total energy transformed and constitute the most efficient light sources known.

Many of these materials also exhibit hysteresis and the behavior of the substance depends upon its previous history. In some cases the change is permanent, in others of a semi-permanent nature. These effects are mainly exhibited when materials are excited by the greater penetrating rays, as x-rays, or those having great energy, as cathode rays. The color change observed in some of the unstable mercury compounds was formerly used in x-ray work for timing the dosage.

Colorless materials like potassium bromide are quickly changed to a permanent dark color by cathode rays, the whiteness again being restored upon heating in air. This brings us to the phenomena of "burning" of fluorescent screens. This so-called burning is due to chemical reduction due to the energy generated as heat by the electrons bombarding the material. That this is true is easily proved by opening the tube, in which the screen has been burned, and heating in air upon which the original color will be restored. This burning only occurs, of course, with the more unstable compounds and is very often due to the binder or adhesive with which the material is applied to the screen.

This burning is very interesting from a theoretical point of view and is the basis for one theory of the physical action occurring in the phenomena of fluorescence.

It appears fairly certain that the exciting radiation bombarding the material releases a cloud of oxygen and that fluorescence occurs only during the re-

combination of this oxygen with the material. The above discussion on burning seems to bear this out. Further, if a material after having been excited by cathode rays in a vacuum is suddenly exposed to a current of oxygen a bright flash will be seen, somewhat similar to that caused by the sudden rise in temperature.

In a brief article of this type is impossible to go into detail on the various phenomena which accounts for this more or less rambling presentation of the various effects. It has been stated that the distribution of intensity of the fluorescent spectrum is independent of the wavelength and intensity of the exciting light. The writer cannot subscribe to this, having observed many cases where the peak energy response increases in wavelength with increase in intensity of the exciting source. This has a very practical aspect in the search for suitable fluorescent screens for television light sources. The most popular material at present for cathode-ray fluorescent screens is zinc ortho-silicate, because the wavelength at which it radiates its greatest energy by cathode rays is very close to the wavelength at which the human eye is most sensitive.

The human eye sensitivity curve shows a peak at 5560 AU and synthetic willemite shows a peak response at 5400 AU.

A more suitable color for television pictures would of course, be white and it is to be supposed that when more energy is available for operation of the tube that white will be used. It must be remembered however that even though white material has the same efficiency as the green from an energy viewpoint, it does not effect the eyes nearly as much and more energy is required to excite it to the same intensity. Several attempts have been made to use a combination of red, blue and green fluorescent materials in proper combination to produce white, but these are not very satisfactory since the rate of decay or afterglow is not exactly the

same in each material and a single compound having the white fluorescence has been found to be desirable for this purpose.

A further difficulty however, is found in the fact that the peak response, or in other words, the predominating hue, shifts to a longer wavelength with increase in intensity.

Now, it so happens, that this is also one of the properties of the human eye and is not one of the properties of light source used in ordinary projection, for example, colored movies. In the latter case the eye is so accustomed to changes in intensity of an illuminated object of a definite color that the imagination helps to complete the illusion. We are not referring to the operation of the iris but rather to the decrease in wavelength to which the eye is more sensitive in dim light; for example, a certain tree will appear more green in bright sunshine and will appear to be more blue in a dimmer light. Therefore, some difficulty can be expected in creation of the television image upon the white fluorescent screen, the predominant hue of which changes to longer wavelengths with increasing intensity simultaneously with same effect occurring in the eye. The overall effect will be that at a lower intensity the picture will be too blue, while at high intensity the picture will be too red. This can probably be compensated for, but should not be underestimated nor overlooked.

The general color (not the specific wavelengths) of all fluorescent materials is very nearly the same regardless of the exciting source. One example of how the total color is modified by wavelength is very markedly shown by some of the minerals. One of the calcites found in Texas shows pink fluorescence by ultra-violet and a blue phosphorescence of quite long duration. The fluorescent band is modified by the phosphorescent band and the pink color is the composite of both bands. This composite nature of color is true of all materials, but to a lesser degree, for it can easily be shown that certain wavelengths of ultra-violet light will cause more light to be emitted from the fluorescent band than the phosphorescent band or vice versa. The color is therefore dependent on wavelength. Both the fluorescent and phosphorescent bands are always present when the exciting source is not mono-chromatic.

A great variety of natural minerals show beautiful and interesting luminescent effects. Some of the most common and easily procured are willemite, hyalite, fluorite, opal, aragonite, wernerite, calcite (the natural mineral as well as the stalagmites and stalactites occurring by deposition in caves) sphalerite, uranocircite, dolomite, richterite, gems

such as, diamonds, rubies, and even synthetic rubies. Fluorescence has been used as a tool for examination of gems as well as for authenticity of paintings, sculpture and other works of art.

FLUORESCENT LIGHTING

Due to the very high efficiencies exhibited by fluorescent materials, they are very attractive to engineers for possible use as a domestic light source when once we learn how to apply it. Experiments in this direction have been made with especially two forms of excitation. As is well known, the low-pressure mercury arc contains several times as much light in the ultra-violet region as is present in the visible range. If this invisible energy which goes to waste can be used to excite fluorescence and added to the visible radiation it is possible that some increase in efficiency may be obtained and certainly the light may be modified to a more pleasing and more useful color. Still greater efficiencies are obtainable by cathodal fluorescence.

The two above types are differentiated by the presence of gas or vapor in the first case in which the fluorescent material is acted upon by both positive and negative ions, electrons and ultra-violet light. By cathodal fluorescence is meant fluorescence excited by comparatively high velocity electrons in a vacuum. Though the efficiencies are high with fluorescent materials the intrinsic brilliancy is low and any consideration of fluorescent light sources must be concerned with large areas. In this way it will be possible to eliminate point sources of light in the home, with their obvious discomfiture to our eyes, and to replace them with sources of large areas of pleasantly diffused light perhaps comparable with that which enters our windows.

In view of the increasing importance of fluorescent materials in radio, television, x-ray and lighting, this company has formed a special Electronic Department for the further study and development of all types of fluorescent materials and their applications in industry.

Fluorescent materials of various types have been manufactured for some years but it has been the privilege of this company to produce and distribute for the first time, fluorescent materials accompanied by measured physical characteristics such as the spectral response, the rate of decay and other properties peculiar to each compound. This it is felt will enable users to predict results and will greatly facilitate their application in many new fields.

REFERENCES

- Wood, R. W., "Physical Optics," third edition, 1934.
Nicholas & Merritt, "International Critical Tables," Vol. 5, p. 386.
Radley & Grant, "Fluorescence Analysis in Ultra-Violet Light," 1933.

TO I R E MEMBERS IN CONVENTION ASSEMBLED

The SUPERIOR TUBE COMPANY of Norristown, Pa., at the close of its second year of operations, announces its readiness to aid in the further development of any Industry problems for which the facilities of the plant are suited.

This second year shows output to be double that of the first. Now footage is recorded in millions of feet.

Come to SUPERIOR with your problems. Here are Headquarters for *fine*, *small* seamless Tubing, in many Metals.

WHERE IS THIS PLANT?

25 miles from Philadelphia
100 miles from New York City

● ●
SUPERIOR TUBE CO.
NORRISTOWN, PENNA.
● ●

CONTROLLING REGENERATION

by Gilbert Oberweiser

ONE OF THE MOST important factors causing the decline in popularity of the old-type regenerative, or feedback, systems was the undesirable frequency characteristics, making receivers using these systems very susceptible to oscillations unless skilfully operated.

However, if the high efficiency of regeneration systems could be maintained, without the difficulty of controlling the feedback produced between the grid and plate circuits, regeneration again might become a useful device for receivers in which great efficiency is necessary.

It is not difficult to remember the characteristics of receivers using the old three-circuit tuner as a means of producing regeneration. With these, if the grid-plate coupling was set at a point of maximum regeneration for reception at 500 kilocycles, the receiver would break into oscillations as soon as it was tuned for reception at any higher frequency. Conversely, if the grid-plate coupling was set at a desirable point at 1,500 kilocycles, the effects of regeneration would diminish to ineffectiveness as the receiver was being tuned to the lower frequencies.

The above observations indicate that the feedback voltage (voltage induced from the plate to the grid circuit) is an increasing function with respect to frequency in this type of arrangement. The mathematical relationship between the feedback voltage and the frequency can be worked out by considering the equivalent plate-circuit diagram shown

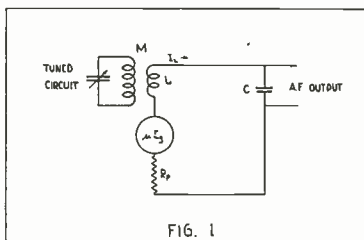

Page 24

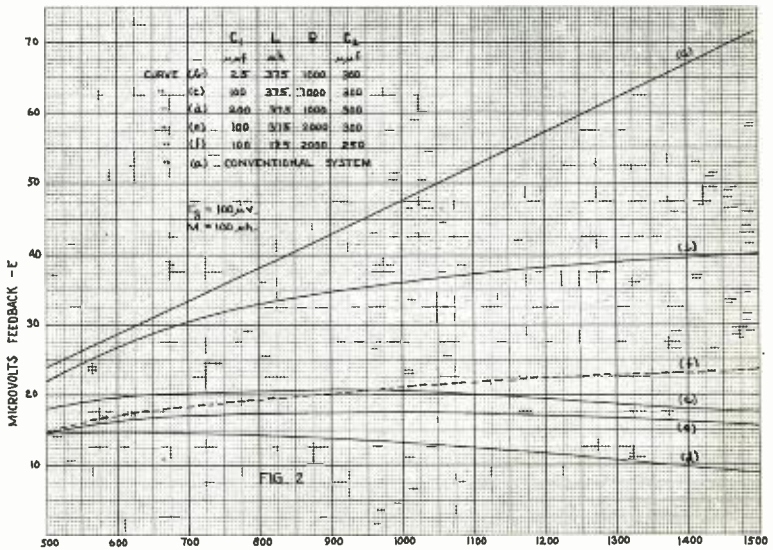

in Fig. 1. Here, the output capacity of the tube is neglected because its effect upon the results is so small that the complexities of its being entered into the solution do not merit consideration.

Primarily, the voltage induced from the plate circuit to the tuned circuit in its instantaneous form is:

$$e = M \frac{di_L}{dt}$$

Or, carrying out the calculus,
 $E = \omega M I_L$ (1)
 where E is the effective voltage, I_L is the current through coil L , and M is the mutual inductance.

The current through this coil, from the plate circuit arrangement is:

$$I_L = \frac{\mu E_p}{R_p + j \left(\omega L - \frac{1}{\omega C} \right)} \dots\dots (2)$$

In standard three-circuit coils, where it was common practice to wind the plate coil with but fifteen to thirty turns, ωL becomes very small compared to R_p in equation (2). The reactance of the by-pass condenser C is also very small at radio frequencies. Thus, with circuit values that were ordinarily used in the conventional three-circuit regenerative system, the vector addition of the condenser and plate coil reactances to the plate resistance of the tube has no noticeable effect. Withstanding this, equation (2) can be simplified to:

$$I_L = \frac{\mu E_p}{R_p} \dots\dots (3)$$

Combining equations (1) and (3), then,

$$E = \frac{2\pi f M \mu E_p}{R_p} \dots\dots (4)$$

Here the feedback voltage, E , is directly proportional to the frequency as was so noticeable in the operation of the old-type regenerative receivers. Curve (a), Fig. 2, derived from a circuit using a 36 tube in which values of M and E_s were assumed, shows this relationship very clearly.

By inspecting equation (4) it can be seen that no matter what values of μ , R_p , and M are chosen, the frequency factor (or the ratio of the highest value of feedback voltage to the lowest value over a given band) will be 3. This comes from the fact that the voltage at 1,500 kilocycles is always three times greater than that at 500 kilocycles in equation (4), no matter what constants are used.

REDUCING THE FREQUENCY FACTOR

If curve (a) in Fig. 2 could be flattened to such an extent that its slope would be nearly zero, or its frequency factor be nearly one, it would be possible to incorporate a scheme of fixed regeneration in receivers. That is, if a circuit could be devised so that this curve could be made to show negligible frequency characteristics, the coupling between the grid and plate circuits could

be fixed at a point near maximum regeneration without danger of the receiver "spilling over" as it is being operated. Such an arrangement would eliminate the hazards of manually-controlled regeneration systems, but would insure the desirable effects of regeneration throughout the waveband.

With this in mind, consider a circuit such as shown in Fig. 3 where L is the feedback coil, R is a resistance in series with L , C_1 is the output capacity of the tube plus another condenser in parallel, C_2 is the conventional by-pass condenser shunting the detector output, and R_p is the plate resistance of the tube.

The layout in Fig. 3 might suggest that there will be a tendency for the higher frequencies to be shunted through C_1 , decreasing the current through coil L at these frequencies, and tending to decrease the voltage fed from the plate circuit back to the grid circuit. This is true. However, with C_1 in the circuit, the set-up is no longer a simple series arrangement, but one in which all the circuit constants become involved. Thus, to study the effect that each of these constants has upon determining the shape and position of the feedback curve, it will be helpful to derive the equation showing the feed-

back-frequency relationship of this circuit.

Using equation (1) as a basis again, it will be most convenient to solve for the plate coil current (I_L) by means of Kirchoff's law:

$$I_L = I_0 - I_1$$

$$I_1 = \frac{\mu E_x}{Z_0} = \left(\frac{\mu E_x - I_0 R_p}{\dot{X}_{c1}} \right)$$

By factoring, reducing and substituting,

$$I_L = \mu E_x \left(\frac{\dot{X}_{c1} - Z_0 + R_p}{Z_0 \dot{X}_{c1}} \right) \dots (5)$$

Solving for Z_0 in order that all the circuit components will appear individually,

$$Z_0 = R_p + \frac{\dot{X}_{c1} (\dot{X}_L + \dot{X}_{c2} + R)}{\dot{X}_{c1} + \dot{X}_L + \dot{X}_{c2} + R} \dots (6)$$

Substituting equation (6) into equation (5), rearranging terms and reducing,

$$I_L = \frac{\mu E_x}{R_p + \left(1 + \frac{R_p}{\dot{X}_{c1}} \right) (\dot{X}_L + \dot{X}_{c2} + R)} \dots (7)$$

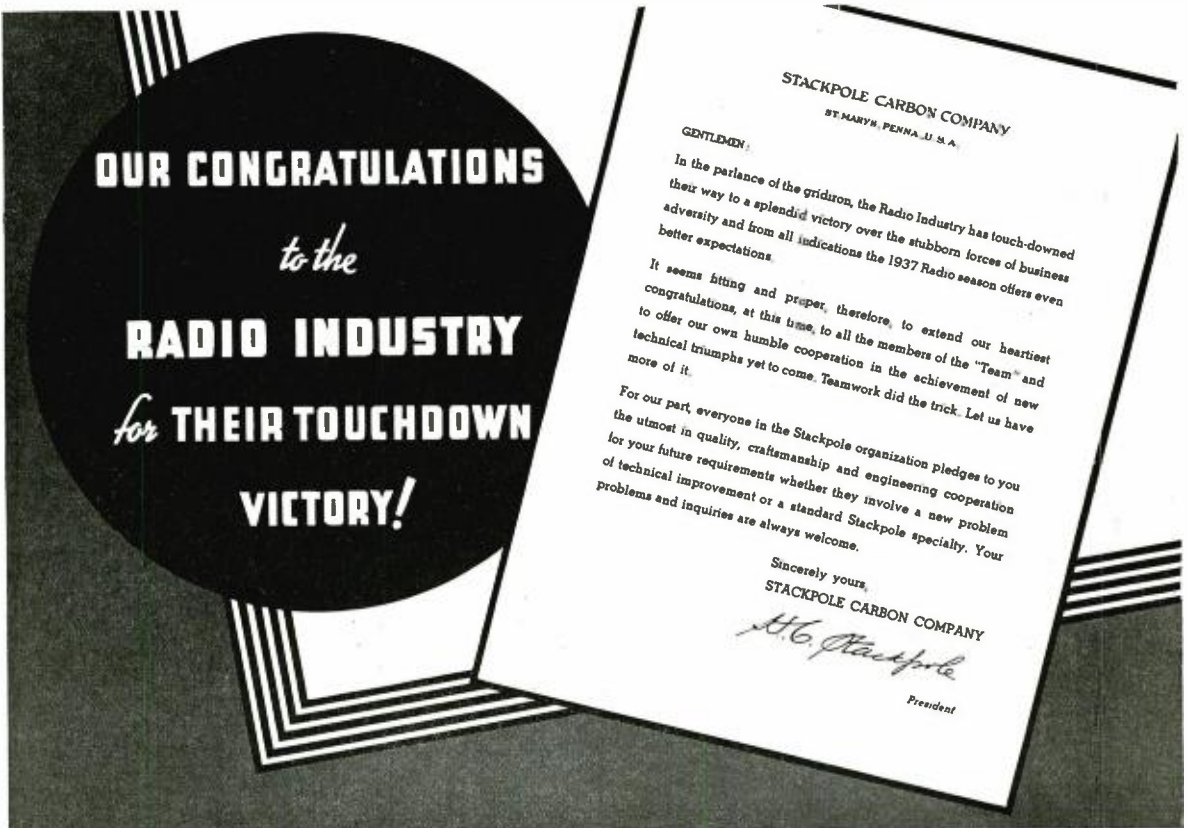

Writing the equation so that it is a function of the frequency,

$$I_L = \frac{\mu E_x}{R_p + (1 + jR_p\omega C_1) \left(R + j\omega L - \frac{j}{\omega C_2} \right)} \quad \dots\dots\dots (8)$$

Substituting this in equation (1) will give the final equation, the relation of the feedback voltage to the frequency:

$$E = \frac{\mu E_x \omega M}{R_p + (1 + jR_p\omega C_1) \left(R + j\omega L - \frac{j}{\omega C_2} \right)} \quad \dots\dots\dots (9)$$

By inspecting the above, it can be seen that the numerator is the same as that of equation (4), but that the denominator is also a function of the frequency. Here the expressions ωL

and $\frac{1}{\omega C_2}$ cannot be dropped as they

were from equation (2) because they are multiplied by the expression $(1 + jR_p\omega C_1)$ of which C_1 is deliberately made large enough to be effective.

In order to keep the frequency factor low, or the feedback voltage E as constant as possible, the value of the denominator in equation (9) must increase at the same rate as that of the numerator as the frequency is varied. An increase of either or both of the parameters C_1 and L will increase the rate of change of the denominator with the frequency. Since R_p appears in the denominator as a constant that is always added to the variable part of the denominator, while the numerator is a pure product, both of the parameters C_1 and L must be made so that their effects in causing the denominator to increase with the frequency will be combined, otherwise the denominator will increase at a slower rate due to the retarding effect of the constant R_p .

To show the effect of varying the parameters, or the circuit constants, upon the type of feedback characteristics obtained, a family of curves (b to f, Fig. 2) was plotted. In calculating these curves, the same values of M and E_x were assumed and the same type of tube was used as for curve (a) in order that the results of the controlled

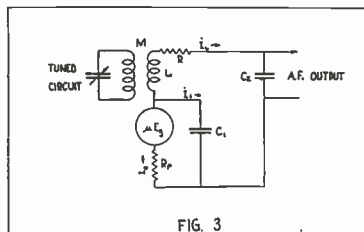

FIG. 3

regeneration system could be compared to that of the conventional type.

Note that when L is made large, the feedback curve falls off more at the higher frequencies as the value of C_1 is increased. In fact, if C_1 is made too large the curve will assume a negative slope. However, if L is not made large enough to assist the effects of C_1 (see curve e), the curve will not become flat until nearly all the feedback current is by-passed. An increase in resistance R tends to attenuate the "hump" predominating in some of the curves, as is shown by comparing curves (c) and (f).

But, inserting resistance R in the main feedback circuit cuts down the overall feedback. Thus, in designing such a circuit as this, the coupling between the grid and plate circuit must be made very close if regeneration is to be effective at all.

The type of tube used with this arrangement has but very little effect upon

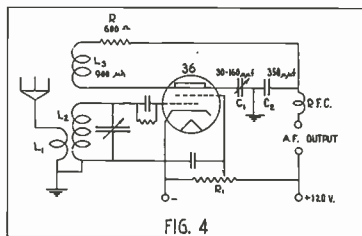

FIG. 4

the frequency characteristics of this type of regeneration system, since the filtering qualities here are mostly determined by the relation of C_1 to L and C_2 .

EXPERIMENTAL DATA

The circuit that was used for testing this arrangement is shown in Fig. 4. The three-circuit coil was constructed in the conventional fashion, excepting that the feedback coil, L_3 , had to be made with a very high inductance in order that its reactance, compared to that of C_2 , could be made to predominate. Furthermore, the high inductance of L_3 was found necessary to produce the required regenerative effects. Also, in order to overcome the decrease in overall regeneration caused by the resistance R and the condenser C_1 , the coupling between L_2 and L_3 was made very close.

R_1 was used as a means of bringing the regeneration up to the desired point after the rest of the circuit constants R , C_1 and C_2 had been adjusted so that the arrangement showed minimum frequency characteristics.

The effect of the circuit constants R , C_1 and C_2 on the regeneration characteristics of the test receiver checked with the theory discussed in the first part of this article. That is, using the

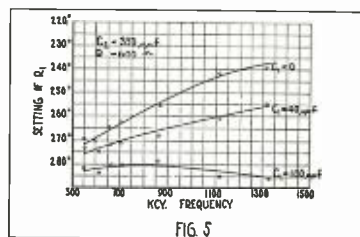

FIG. 5

values of L_3 and C_2 designated in Fig. 4 and varying C_1 as the parameter, it was found that the receiver could be adjusted so that the effect of regeneration was fairly constant throughout the broadcast band, or so that regeneration was more effective at either the top or the bottom of the band.

The curves shown in Fig. 5, which were taken by means of calibrating R_1 , show the relationship between the frequency and the point of oscillation of the test receiver. To obtain these curves, the regeneration control, R_1 , was advanced to the point at which the receiver was at the verge of oscillation. The reading of R_1 was then taken. This process was repeated at various points on the broadcast band (from 500 to 1,500 kc). These performance curves are important inasmuch as their flatness is the object around which the whole scheme is centered; they also are directly comparable to the theoretical curves of Fig. 2 since there is a direct relation between the point of oscillation of a receiver and the feedback voltage.

Note that the curve taken with $C_1 = 0$ approaches the condition noticed in the conventional regeneration system. The flat top of this curve is probably due to the abnormally high impedance of L_3 and the output capacity of the tube.

The value of C_2 also had an effect upon the frequency characteristic of the regeneration system. By increasing C_2 regeneration was found to be more effective at the lower frequencies. The reverse was found to be true if the value of C_2 was materially reduced. The reason for this can be seen by referring back to equation (9) where, by inspection, it will be noted that an increase in C_2 has the same effect as an increase in L .

Although an increase in R cuts down the overall regeneration, it was found desirable to have R as high as feasible because of the reason explained in the theoretical discussion (see curves (c) and (e), Fig. 2).

When a type 77 tube was substituted in place of the 36 used above, there was no noticeable change in the frequency characteristics of the arrangement. However, due to the higher mutual conductance of the 77, the overall feedback was increased necessitating lower settings of the potentiometer R_1 .

FROM

TRANSMITTER

TO

Antenna

A Complete Installation with
ISOLANTITE COAXIAL
TRANSMISSION LINE



WESTERN ELECTRIC ultra high frequency Police Radio Transmitter, Station W2XEM, Newark, N. J.



National Newark and Essex Bank Building, Showing location of transmitter and antenna connected by ISOLANTITE COAXIAL TRANSMISSION LINE.

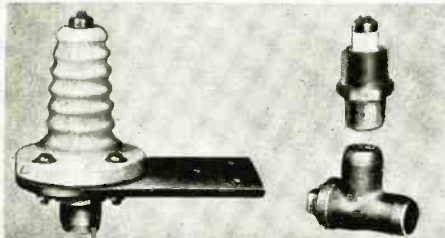

In the rapidly developing technique of radio communication engineers recognize the coaxial transmission line as the most efficient means of conducting radio frequency energy from point to point and from transmitter to antenna.

ISOLANTITE INC. has been closely identified with this development and now announces A COMPLETE COAXIAL TRANSMISSION LINE SYSTEM for ultra high frequency and broadcasting stations.

Write for our complete bulletin on this product. ISOLANTITE INC., 233 Broadway, N. Y. C. Factory at Belleville, N. J.

Sold only through Graybar Electric Company and Manufacturers of transmitting equipment

Isolantite
CERAMIC INSULATORS

(Continued from page 6)

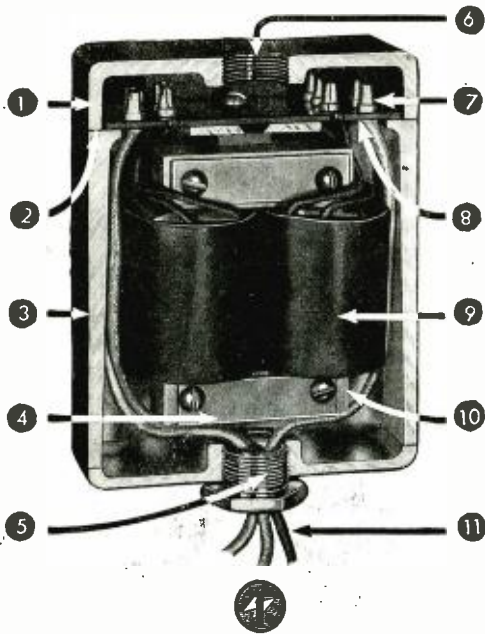

**Most Sensational
New Idea in Radio**

- 1 **Shield Cap**—No stray pickups in leads—improves appearance—permits reversible mounting.
- 2 **Ground Fit**—All case joints are ground fit for increased shielding efficiency against outside interference.
- 3 **Case Body**—Special metal, gives maximum transformer shielding and a closed magnetic circuit at all times.
- 4 **Non-Magnetic Clamps**—Brackets and clamps non-magnetic metal. Core and coils held in perfect symmetry.
- 5 **Single Hole Mountings**—Drill one hole in chassis. Pass connecting leads through bushing. Rotating of transformer prevents hum pickup.
- 6 **Reversible Mounting**—Threaded mounting hole. Fits microphone fixture—for above or sub-panel mounting.
- 7 **Terminal Board**—Husky mounting lugs for all connections. Terminals will not loosen when soldering.
- 8 **Sub-Panel Terminals**—Extra row of terminals provides connections for both primary and secondary windings.
- 9 **Coils**—Dual balanced coils for "hum bucking". Extended frequency range. Capacitive—inductive balance. Low leakage reactance. Distributed capacity.
- 10 **Core**—Special lamination. High permeability alloy of perfect uniformity. Extreme low frequency response.
- 11 **Sub-Panel Leads**—Pass required leads from sub-terminal board through bushing. Neat—efficient—effective.

FREE—CATALOGS and BULLETINS

Catalog No. 500 Lists Tru-Fidelity prices, curves, and all specifications.
Catalog No. 400—Complete listing of all THORDARSON radio transformers except Tru-Fidelity.
Send today for your copy or see your PARTS DISTRIBUTOR.
6L6 amplifier with either Tru-Fidelity or standard THORDARSON transformers. See Bulletin SD-258.

THORDARSON ELECTRIC MFG. CO.

500 W. HURON ST., CHICAGO, ILL.

Demand "Power by Thordarson"

illator circuit unfortunately has considerable amplitude of harmonic frequencies. Whenever the harmonic frequency of the oscillator was tuned through a frequency of approximately 200 mc, a serious hiss point was formed, which in some cases was louder than the signal in the speaker.

The hiss points were eliminated by removing all external circuits from the proximity of the first detector and oscillator tube which might resonate to 200 megacycles. The filament circuits were especially susceptible to this type of radiation. Special tube sockets were used, for both the oscillator and detector tubes, in which the terminals were brought out between the bakelite wafers and soldered directly to chassis to obtain a low-impedance ground connection. Small by-pass condensers were also soldered from the tube sockets directly to chassis with as short leads as possible to reduce resonant circuits.

An important requirement in the design of a radio receiver is stability of the circuits with respect to weather conditions, line voltage variations, temperature of the chassis and aging of the various components.

In general, the Magic Brain structure incorporates the best type of bakelite insulation for coil forms and for the mounting strips of the variable condenser. Bus wiring is used for nearly all high-potential circuits and proper precautions are taken in the design layout so that high potential radio-frequency leads do not touch other leads or component parts having a poor grade of insulation. Multi-layer coils are impregnated at high temperature with the best grade of wax to render them impervious to moisture or humidity changes.

All mica compression trimmers have been eliminated and air trimmers and magnetite cores substituted for these adjustments. A total of 15 air trimmers are included in the Magic Brain coil structure. Extensive life tests indicate that these new type adjustments are very slightly affected by humidity and temperature changes and by fatigue of the various component parts. The fixed mica condensers used in the Magic Brain are vacuum impregnated at high temperature and have an appreciable corrective temperature coefficient with changes in temperature.

The oscillator circuit stability versus a-c line voltage change is improved in the Magic Brain by the proper choice of circuit constants, chiefly the value of the grid and plate blocking condensers. A large improvement is easily obtained over a narrow band of frequencies, but it is difficult to extend the improvement over a multi-band structure. By choosing a point of stabilization which is close to the high-frequency end of a tuning range, the maximum improvement is obtained over the entire band due to the reduction of the L/C ratio at the lower frequencies. The oscillator frequency stability is improved by the use of a high-Q coil for the tuned circuit and the reduction of the external coupling to the first detector to a minimum. The addition of series resistors to the plate and screen circuits of the oscillator also reduces the frequency shift since these resistors have a regulating effect on the voltage supply to the oscillator.

It was also determined that there existed a connection between the percentage harmonics of an oscillator and frequency stability. Since it is possible to choose circuit constants for maximum frequency stability over only a narrow range of frequencies, the introduction of appreciable harmonic frequencies tends to counteract the sta-

bility since the circuit constants are not chosen for the harmonic frequencies. The Hartley-type circuit is advantageous in this respect since it produces relatively weak harmonic frequencies.

A separate oscillator and detector tube was found to be considerably superior to the combination tube 6A8. In the 6A8 type the R_p of the oscillator section is dependent to a large extent upon the control-grid bias and screen voltages. If AVC is employed, a change in R_p of the oscillator section will occur if the AVC is changed which results in a change in frequency. In cases of severe fading and high signal strength on short waves, the signals sometimes fade and never return because the oscillator has shifted frequency.

All Magic Brain models incorporate the magnetite core oscillator adjustment on the X and A bands. In this circuit the low-frequency series condenser, which usually consists of a multiple-layer compression-type mica condenser, is eliminated and a fixed close tolerance mica condenser substituted. Exact alignment at 600 kc and 175 kc, on the A and X bands, respectively, is obtained by changing the inductance of the tuned circuit with a magnetite core. Fig. 10 shows the mechanical construction of the A, B and C band oscillator coil. The magnetite core is fastened through a brass stud to the top of the shield can. By adjusting the position of the magnetite core with respect to the A band oscillator coil, the inductance may be varied for exact alignment with the radio-frequency circuits.

The new design air trimmer is only slightly changed in capacity by extreme weather and temperature conditions and shows no appreciable capacity change under ordinary temperature and humidity conditions. The details of the mechanical construction are shown in Fig. 11.

The condenser consists of a small hollow brass cylinder or stator through which a sliding brass rod is placed to form the two surfaces of the condenser. The cylinder is insulated from the mounting stud and sliding rod by a second cylinder of porcelain which is die-cast integral with the stator and mounting stud. A small porcelain ring is fastened to the end of the sliding rod which is slightly larger in diameter than the rod to prevent shorting the rod to the stator. A short bus wire is also included in the die-casting for the stator to connect to the tuned circuit.

The capacity of the condenser is adjusted by sliding the brass rod up or down the cylinder with a slight twisting motion. When the condenser is adjusted to the proper capacity a locking nut is tightened down over the upper end of the mounting stud to hold the rod rigidly in place.

In order to test the stability of the Magic Brain construction with changes in relative humidity, a production model 10T was placed in a humidity room and maintained at a temperature of 100°F and a relative humidity of 95% for 103 hours. This type receiver incorporates the Magic Brain and magnetite intermediate-frequency transformers. Measurements of overall sensitivity and scale calibration were made before and after the test. The results indicated that the maximum reduction in sensitivity averaged 3 to 1 over all bands and that the maximum change in scale calibration was 0.75% at 20,000 kc. The maximum change on the broadcast band was 10 kc at 1,500 kc.

A comparable receiver of the 1936 RCA line, which contained mica compression trimmers in the radio-frequency circuit and mica compression trimmers in the intermediate-frequency amplifier, was practically inoperative after such a severe test.



The RIGHT COMBINATION at your fingertips



New CENTRALAB SELECTOR SWITCHES FOR

- Analyzers
- Output Meters
- RF Oscillators
- Tube Checkers
- Decade Boxes
- Capacitance
- Resistance
- Ham Equipment
- PA Work
- Volt-Ohm-Am Meter
- Radio Receiver Replacements

Here's some light on that SELECTOR SWITCH PROBLEM, you Knight of the soldering iron.

If the circuit calls for more lugs than a centipede has feet, scam over to your jobber and make up your own SELECTOR SWITCH . . . thousands of different combinations possible with a CENTRALAB Kit at his place.

Centralab

Division of Globe-Union Mtg. Co.
MILWAUKEE, WIS.

British Centralab, Ltd.
Canterbury Rd., Kilburn, London, N. W. 6, England

French Centralab Co.,
118 Avenue Ledru-Rollin, Paris XI, France

CENTRALAB Selector Switch



FIRST NATIONAL PARTS SHOW AT STEVENS HOTEL, CHICAGO

Applications for exhibit booths in the first National Parts Trade Show, under auspices of the Radio Manufacturers Association and also the Institute of Radio Engineers, at Chicago, next spring, soon will be forwarded to all manufacturers of radio parts, accessories and tubes. Rapid progress on plans for this first national parts show has been made by committee of RMA, IRE and also the Sales Managers Club, the latter representing parts manufacturers and including some companies not members of RMA. A joint show operating committee is contemplated following a preliminary meeting at Chicago.

The Stevens Hotel, Chicago, because of its unusual exhibition facilities, has been chosen for the National Parts Trade Show, which will be held either late in May or early in June and probably in conjunction with the thirteenth annual convention of the RMA and also spring meetings of the IRE.

President Muter of the RMA has sent out an announcement of definite arrangements for the parts show. Exhibits will be confined to parts, accessory and tube manufacturers but displays of receiving sets will be barred. In deciding to proceed with the National Parts Trade Show the RMA directors specifically limited exhibition privileges to parts, accessories and tubes, having definitely decided not to proceed with the former annual trade show including receiving sets. Also frowned upon by set manufacturers, as expressed at the RMA board meeting, was exhibition in various public shows which are regarded as local and not desirable for participation by set manufacturers.

All individuals and organizations of parts and accessory trade-distributors, dealers, factory representatives, engineers and service men will be invited to the National Parts Trade Show at Chicago. In announcing arrangements for the show, President Muter of the RMA said that its organization would promote maximum attendance of the trade and also manufacturers.

"A major objective also of the National Parts Trade Show which will be held by RMA and IRE," said President Muter in his formal announcement, "will be reduction of expense for exhibiting manufacturers and to reduce obligations of exhibition in the many parts shows which had been held throughout the country."

During the parts show at Chicago an interesting program is being planned, including meetings of RMA, IRE and other trade groups and committees.

In addition to the parts trade show at Chicago next spring, the RMA board also has authorized cooperation with the IRE in arranging another parts trade show in New York next fall. With these two national exhibitions for parts, accessory and tube manufacturers it is believed that the great stimulus to the trade will be developed and exhibition interests concentrated in these two nationally organized parts exhibitions.

JULY LABOR INDICES

The latest labor report, for July, 1936, of the U. S. Department of Labor, Bureau of Labor Statistics, showed decreases in the radio industry compared with the previous month of June. There was a decrease of 3.4 percent in July employment and 7.5 percent in payrolls. Employment, however, was 26.6 percent above that of July, 1935 in radio and phonograph factories reporting, while payrolls were 32.7 percent above those of July, 1935. The July employment index figure was 234.2 compared with the three-year official average of 1923-25, while the July index figure on payrolls was 149.9 compared with the three-year official average.

Average weekly earnings in radio factories last July were \$19.74 compared with \$20.69 during the previous month of June, a decrease of 4.2 percent, but they were 5.0 percent above average weekly earnings of July, 1935. For all durable goods manufacturing industries, the average weekly earnings in July were \$24.84.

Average hours worked per week in radio factories last July were 37.8 hours, a decrease of 2.4 percent from the previous month of June, but 8.4 percent above July, 1935. The national average in all durable goods factories last July was 39.7 hours.

Average hourly earnings last July of radio factory employees were 52.4 cents, a decrease of 1.7 percent compared with the previous month of June, and 3.5 percent less than July, 1935. In all durable goods factories the July average hourly earnings were 61.6 cents.

GERMAN SALES DECLINE

Reduced sales of receiving sets in Germany during the fiscal year ending July, 1936, as compared with the previous year are reported to the U. S. Bureau of Foreign and Domestic Commerce. For the year ending in mid-July, 1936, the German set sales were only 1,177,000 compared with 1,776,000 sets during the corresponding previous year. Improvement, however, in the German market was reported in reduction of inventories to 200,000 sets last July as compared with 364,000 on hand in July, 1935. German radio listeners are reported to have increased from about 6,500,000 to 7,700,000 and it is estimated, therefore, that only about 150,000 new receivers were sold as replacements during the year last July. Improved conditions in the German market during the present fiscal year are expected, according to the reports to the U. S. Bureau of Foreign and Domestic Commerce.

RMA ASKS TARIFF COMMISSION TO BAR JAPANESE CONDENSERS

Tariff action against imports of cheap Japanese carbon resistors has been asked of the U. S. Tariff Commission by the RMA. Immediate relief may be possible under President Roosevelt's executive powers to prevent destructive or injurious

competition. The imported Japanese condensers are selling at about half of the American price and seriously injuring interests of American employers and labor.

The RMA is prepared to submit detailed evidence of the harmful Japanese competition. The data is being collected by a special RMA committee of which Arthur Moss of New York is chairman and Fred D. Williams of Philadelphia and John E. Schunck of Lakewood, Ohio, are members.

FRENCH PROPAGANDA AGAINST U. S.

French manufacturers are active in propaganda against American radio imports, according to reports which have reached the RMA. The radio trade press of France, it is stated, contains attacks against American radio, charging that imports of radio parts from the U. S. have injured French manufacturers. Reduction of American import quotas under the reciprocal trade treaty with France is an apparent object of the French manufacturing interests and other French industries are also agitating for additional protective tariff action.

The RMA export committee, of which S. T. Thompson of Long Island City is chairman, has called the matter to the attention of the State Department at Washington, to protect the American trade interests involved. As the American import quotas are definite treaty obligations, it is not believed that the French propaganda and other efforts for reduction of the American quotas will bring any results.

CHILEAN EMBARGO PROTESTED

Relief from the recent embargo by Chile against importation of American radio receivers has been requested of the State Department at Washington by the RMA, through Chairman S. T. Thompson of the Association's Export Committee. Secretary Hull was advised that American manufacturers are unable to ship receivers into Chile because of the embargo and that Germany is reported to have a more favorable trade agreement which permits German manufacturers to encroach on the market enjoyed in the past by the American radio industry. The RMA has requested the State Department to use all possible efforts to protect American interests in the Chilean market.

CLEAR CHANNEL, HIGH POWER AND SHORT-WAVE BROADCASTING URGED BY RMA AT FCC HEARING

Among important broadcasting recommendations made at the allocations hearing of the Federal Communications Commission at Washington beginning October 5, the RMA strongly urged maintenance of clear channels, high power and expansion of short-wave broadcasting. Several hundred representatives of broadcast stations, networks, educational and other organiza-

(Continued on page 34)

**Pick-up
your phone
...and
We pick-up
your
Shipment**



... that is all that need be done to have your shipment, large or small — shipped swiftly, safely and economically anywhere by Railway Express. Prompt pick-up by a swift motor vehicle, "hurry-up" service on fast passenger trains, and speedy delivery to destination. Railway Express' 57,263 skilled employees and 23,000 offices are ready for instant action when you pick up your 'phone. Free insurance up to \$50 covers every shipment and additional liability costs only 10 cents per \$100 valuation. For service or information telephone the nearest Railway Express Agent.

RAILWAY EXPRESS
AGENCY INC.

NATION-WIDE RAIL-AIR SERVICE

NOVEMBER, 1936

A recognized source of supply for
RADIO PARTS
of Copper and Copper Alloys



VACUUM tube base pins, plug and socket parts, eyelets, rivets, grommers, terminals, contacts, aerial hardware, electrodes, fuse clips, sockets, screw shells, condenser shells, miscellaneous stampings, shells, etc. The Waterbury Brass Goods Corp., as this division of The American Brass Company was formerly known, has long been a recognized source of supply for these and similar radio parts of copper and copper alloys.

Terminals

We maintain hundreds of tools and dies for producing terminals in an almost endless variety of styles and sizes. The use of stock terminals is recommended as an advantage in prompt delivery and lower tool and production cost. As a service to customers our engineers will recommend the stock terminal best suited for any requirement, provided samples or drawings of the parts with which it is to be used are submitted for inspection. This service involves no obligation.



The comprehensive scope of our lines and the unvarying high quality of our products . . . combined with prompt and efficient handling of orders and inquiries . . . provide an ideal service for manufacturers of electrical and radio equipment. May we quote on your present requirements or cooperate with you in designing new parts from the standpoint of production economy?



WATERBURY BRASS GOODS BRANCH

The American Brass Company

General Offices: Waterbury, Connecticut

NEW PRODUCTS



GENERAL RADIO MEGOHMMETER

The General Radio Company's Type 487-A Megohmmeter applies the simple principle of the ohmmeter to resistance measurements in the megohm range. The requisite sensitivity is obtained by using a vacuum-tube voltmeter as the indicating means.

The range is from 20,000 ohms to 50,000 megohms in four overlapping ranges, so chosen that all values of resistance within the normal range of the instrument can be read on the open portion of the scale.

— RE —

HAMMARLUND HIGH-FREQUENCY CONDENSERS

A new series of ultra-high-frequency variable condensers, known as the HF micro-condensers, has just been created by the Unit Development Division of the Hammarlund Mfg. Co., Inc., 424 W. 33rd St., New York City.

The group includes single and dual models in a variety of sizes. Both types have cadmium-plated soldered brass plates with B-100 Isolantite, for insulation, to insure lowest losses, rigidity and stability.

— RE —

QX-CHECKER

A precision instrument for the production testing, grouping and adjusting of coils and condensers at radio frequencies, permitting greater accuracy in less time than previously available test equipment, is announced by the Boonton Radio Corporation, Boonton, N. J. Known as the type 110A QX-Checker, this instrument provides a simple, dependable, stable method of comparing the Q, as well as the L or C of a radio component, with a given standard. The Q of coils is directly read in percentage variation from the given standard, the standard being rated at 100%.



CORNELL-DUBILIER POWER FACTOR CONDENSERS

The Power Factor Division of the Cornell-Dubilier Corporation, South Plainfield, New Jersey, recently announced a change in the design of their box type Power Factor Correction Capacitors. These new units exceedingly compact, and flexible, are easy to install, lending themselves very readily to various applications. The greatly improved mechanical and electrical features of these units plus their simplicity of installation, make them particularly feasible for modern economical power factor correction and adjustment. It is possible to mount these capacitors on the ceiling, wall or floor in single units or compact groups up to 100 kva.

Full descriptive bulletin furnished free of charge upon application at the South Plainfield office of the Cornell-Dubilier Corporation.

— RE —

FERRANTI POWER UNITS

Ferranti Electric now offers to the radio and electronics fields a new line of hum free plate-filament transformers and filament chokes. These new units embody a self-shielding core-type construction with hum-bucking windings. This method of building is said to eliminate hum at its source, resulting in a minimum of interference. They are designed for low regulation, high efficiency and low core and copper losses. Each transformer is fitted with electrostatic shields between windings. All units are mounted in the new Ferranti completely reversible case requiring minimum space for mounting and connections. Write to the manufacturer at 30 Rockefeller Plaza, New York, for complete descriptive literature.

— RE —

PHENOL RESIN

A new type of extremely flexible phenolic resins, which combine the great bonding strength, water-acid-and-alkali-resistance and friction resistance of a conventional resin with a high degree of flexibility, has recently been developed by General Plastics, Inc., North Tonawanda, N. Y. These new Durez resins are widely used for impregnating fabrics, woven belting, brake lining, and the like, and are so flexible that a fabric impregnated with them can be sharply creased repeatedly with no sign of fracture, nor does aging change this quality. Flexible abrasive cloth and waterproof sandpaper treated with these resins have greater water and oil resistance, and brake linings of the woven type show much longer wear and a more uniformly stable coefficient of friction.

— RE —

ARCTURUS MARKETS 25B5 AND 25N6-G TUBES

The Arcturus Radio Tube Company, Newark, N. J., has added to its line a 25B5 and its octal base counterpart, 25N6-G, tubes. This is a duplex-triode power output tube permitting circuit simplicity, and it is particularly designed for ac-dc sets.

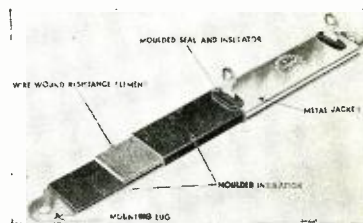

CLAROSTAT MR SERIES

Combining the advantages of Bakelite molded insulation with those of the metal jacket, the new Clarostat Series MR wirewound metal-clad resistors are said to present a radical departure from any previous technique. Thorough hermetic sealing provides maximum protection against humidity and electrical leakage. Continuous contact between winding core and the Bakelite molded insulation, plus a snugly fitted metal jacket clamped flush against the metal chassis, provides maximum heat dissipation.

— RE —

"SILENT RADIO"

A device which permits a person to listen to radio programs without disturbing others has been developed by the Dictograph Products Co., Inc., 580 Fifth Avenue, New York City. The so-called bone-conduction oscillator is employed.

— RE —

DU MONT OSCILLOGRAPH

Allen B. DuMont Laboratories, Inc., Upper Montclair, N. J., have recently announced their Type 158 cathode-ray oscillograph with 9-inch cathode-ray tube. This portable unit is designed for laboratory work or lecturing. The completeness of this oscillograph and the 9-inch tube enables exact wave analysis. The trace, due to the high voltages used, is very brilliant and may be readily observed in daylight at a distance of thirty or forty feet. This oscillograph is the complete combination of all the features incorporated in other DuMont units.

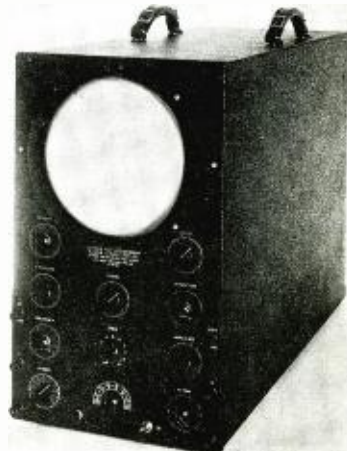



**N
E
W**

NEOBAM OSCILLOSCOPE

"MAKES SOUND VISIBLE"

- ✓ Super-Sensitivity—1 Microvolt.
- ✓ 4 inch Calibrated Screen.
- ✓ Self Contained Power Supply and Sweep System.
- ✓ Simplicity of Operation.

Latest development in oscilloscopes—uses new Modulated Neon Beam principle—opens new field in audio measurement. Checks modulation, locates distortion. Excellent for amplifier, microphone and speaker response. Used in wave form study or as a super-sensitive galvanometer and vacuum tube voltmeter. The unit as illustrated measures 8 3/4" wide, 10" deep and 13" high. Beautiful etched chrome finish on panel. **\$40 net** Durable and fully guaranteed. complete

Send for full details today.

SUND ENGINEERING CO.

Affiliate of Littelfuse Laboratories

4244 Lincoln Ave. Chicago, Ill.

Get Action

PARTS MANUFACTURERS

Tell your story to the chief engineers and associates who actually control purchases.

MATERIAL SUPPLIERS

Our paid subscription list includes over 2000 radio manufacturing plants in which more than 4500 different items are made on a production basis.

RADIO ENGINEERING

has complete buying power coverage of the entire Radio Industry. Get Action! Advertise in the December issue. Forms close Dec. 5th.

NEW TUBES

The Raytheon Production Corp. has announced the 6H5 Tuning Indicator tube: the characteristics are given below:

Heater rating			
Heater voltage	100	200	250 v
Heater current	0.5	1.0	1.0 ma
Tuning Indicator			
(Operating conditions and characteristics)			
Plate supply	100	200	250 v
Series triode plate resistor	0.5	1.0	1.0 meg
Target	100	200	250 v
Target current (approx.)	1.5	3.5	4.5 ma
Grid voltage for zero shadow angle	-8.0	-10.5	-22.0 v
Grid voltage for 90° shadow angle	0	0	0 v

The 6H5 is a high-vacuum tube designed to visually indicate the effect of changing the control grid bias. The shaded pattern produced on the fluorescent target varies through an angle from 90° to approximately 0° as the control voltage is varied. The voltage on the shadow control electrode, the extension of the triode plate between the cathode and target, controls the extent of the shaded area. The voltage of the shadow control electrode is determined by the voltage of the control grid of the triode connected as a d-c amplifier. Thus the control-grid voltage determines the extent of the shadow. An increase of control grid bias increases the shadow control voltage and decreases the shadow while a decrease of bias reduces the shadow. In practical use the control grid voltage is obtained from a suitable point in the avc network.

The 6H5 is similar to the type 6G5 except that the current to the target is controlled by a grid tied to the cathode within the tube instead of by emission saturation as in the 6G5. The addition of this grid causes a fixed 90° shadow to appear on the target opposite the controlled shadow and care should be used in installing the tube that this shadow is not mistaken for the controlled shadow.

RCA Radiotron is making available, through their transmitting tube distributors, the 913 cathode-ray tube. This is a high-vacuum, low-voltage electrostatic type. In appearance the 913 is quite different from the conventional cathode-ray tube. It is constructed like the all-metal receiving tubes, except that the end of the metal shell is replaced by a fluorescent-coated viewing screen.

The tentative characteristics are as follows:

Heater voltage (a-c or d-c)....	6.3 v
Heater current	0.6 a
Fluorescent-screen material	Phosphor No. 1
Direct interelectrode capacitances:	
Control electrode to all other electrodes	10.5 max μmf
Deflecting Plate D ₁ to deflecting Plate D ₂	3.6 max μmf
Deflecting Plate D ₂ to deflecting plate D ₄	4.3 max μmf
Maximum overall length.....	4 3/4"
Maximum diameter	1-23/32"
Base	Octal 8-pin
High-voltage electrode (anode No. 2) voltage.....	500 max v
Focusing electrode (anode No. 1) voltage	125 max v
Control electrode (grid) voltage, never positive	
Grid voltage for current cut-off*.....	-90 approx v
Peak voltage between anode No. 2 and any deflecting plate.....	250 max v
Fluorescent-screen input power per sq cm.....	5 max mw
Typical operation:	
Heater voltage	6.3 v
Anode No. 2 voltage.....	250 v
Anode No. 1 voltage**.....	50 v
Grid voltage	Adjusted to give suitable luminous spot
Deflection sensitivity:	
Plates D ₁ and D ₂	0.15 0.07 mm/v d-c
Plates D ₃ and D ₄	0.21 0.10 mm/v d-c

* With approximately 100 volts (to focus) on anode No. 1.

** Approximate.

**YOU
want a
Strand
that
Lasts
-and here
it is.**



Our Sparrow's Point plant is one of the few in America making only Strand and Guard Fence—a highly specialized organization whose aim is to produce a product of unusual merit.

Send for special catalog.

**WILLIAMSPORT
WIRE ROPE CO.**

122 So. Michigan Ave., Chicago, Ill.
Williamsport, Pa.

Other Offices in All Principal Cities

JOSLYN MFG. & SUPPLY CO.

20 N. Wacker Drive, Chicago, Ill.

National Distributors

Page 33

CAL-LUX FLUORESCENT MATERIALS

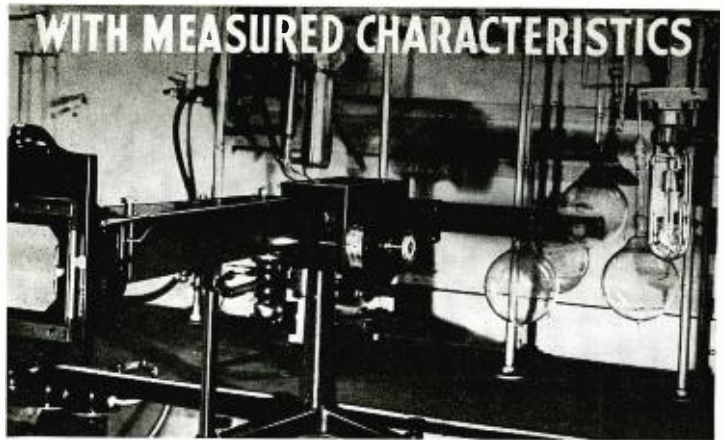

... take all the guesswork out of fluorescence!

BE SURE of your results by using Cal-lux Fluorescent Materials with Measured Characteristics.

Information on the spectral response, rates of decay and other special properties accompanies each type of material.

Order Cal-lux fully tested Fluorescent Materials for long life and dependable performance.

Manufacturers and engineers are invited to write for technical information.

Tungsten and Molybdenum Products • Contacts • "Calliflex" Thermostatic Metal

CALLITE PRODUCTS DIVISION

EISLER ELECTRIC CORPORATION

542-39th STREET

UNION CITY, N. J.

RMA NEWS

(Continued from page 30)

tions appeared at the comprehensive inquiry of the Commission to improve radio service to the public. The entire Federal Communications Commission attended the hearings with Judge E. O. Sykes, chairman of the Commission's Broadcast Division, presiding, and with detailed examination by Commander T. A. M. Craven, chief engineer of the Commission.

The RMA presentation included three resolutions on broadcasting, adopted by the Association's Board of Directors on September 24 at New York. These were presented October 6 at the Commission's hearing by Bond Geddes, executive vice president and general manager of RMA. Also detailed engineering data on receiver fidelity and selectivity, discussion of interference problems and a special recommendation for a protected i-f frequency were presented for the RMA by L. C. F. Horle* representing the Association's engineering committee which assembled the technical data. At the conclusion of the RMA statements, appreciation of the Communications Commission for the effort and information of RMA were expressed by Chairman Sykes at the suggestion of Chief Engineer Craven. The latter also announced that the Commission would be glad to begin work soon in cooperation with an engineering committee of RMA on the problem of a protected i-f frequency.

Clear channel and super-power broadcasting were the principal subjects in controversy among broadcasting groups and interests at the Washington hearing. The RMA declared in favor of present clear

*Mr. Horle's remarks are printed in full on another page.

channel broadcasting as a public service, for removal of present restrictions against increase of power, and that the Commission establish minimum power requirements for clear channel stations.

Commercial licenses for short-wave broadcasting stations also were urged by RMA, in order to give constant and better radio service to a larger audience and areas. Another recommendation of the RMA was to promote the broadcasting of short-wave programs by small local stations with the consent of the originating station.

Great improvement in radio receivers at lower cost to the public were cited in the RMA presentation on receiver fidelity and selectivity. That future improvement of receivers depends greatly on transmission development was stressed.

Following are the three resolutions of the RMA Board of Directors which were presented to the Commission:

Clear Channels—High Power—Whereas the Radio Manufacturers Association is of the opinion that the clear channel stations render a distinct service to the listening public of the United States, due both to the fact that no other stations are on the same wavelength, and, just as important, because the clear channel stations, as a general rule, are high-powered stations serving large territories and affording good reception to communities remote from broadcasting stations. The elimination or impairment of clear channels would thus result in poor and practically unintelligible response to many listeners by reason of the interference of stations who might be on the same wavelength, thereby greatly restricting the use and quality of reception of a large majority of people, particularly in the remote and rural areas, and also would

tend to restrict the power used by stations. Therefore, be it resolved, That the Board of Directors of the Radio Manufacturers Association recommend to the Federal Communications Commission that clear channels be retained as they now are; that restrictions as to increase of the power used by these stations on clear channels be withdrawn and that the Commission establish minimum power requirements for such clear channel stations.

Commercial Status For Short-Wave Stations—Whereas the Radio Manufacturers Association is of the opinion that short-wave broadcasting in this country is far behind that offered by foreign short-wave stations, and that because of this situation many of our nationals residing in foreign countries, as well as citizens of other countries, are thus deprived of the opportunity of listening to the United States programs, and

Whereas good short-wave broadcasting would reach and serve many locations in this country where, because of remoteness from regular broadcasting stations, bad static conditions, and other natural conditions, daytime reception on the standard broadcast band is practically impossible and nighttime reception is poor, and

Whereas the Radio Manufacturers Association is of the opinion that the building of higher-powered, more efficient short-wave broadcasting stations with better and more regular programs is being retarded, if not entirely stopped, because licenses for the operation of short-wave stations in this country are on the experimental basis only, and commercial use and sale of the time of these stations is denied to their owners and operators,

Therefore, Be It Resolved, That the Board of Directors of the Radio Manufacturers Association recommend to the Federal Communications Commission that restrictions as to commercial use in the sale of time by the short-wave stations of this country be eliminated, and that said short-wave broadcasting stations be placed on the same commercial basis as the broadcasting stations on the standard broadcast band.

Short-Wave Rebroadcasting—Whereas under the present rules it is unlawful for any broadcast station to pick up a short-wave program and rebroadcast it, and

Whereas there are many low-powered, local stations serving communities, who because of their lack of power and consequent small coverage are unable to maintain and broadcast good programs, therefore, necessitating the use of phonograph records and in some cases the pick-up of programs of larger broadcast stations and their rebroadcast with the permission of the originating station, the latter is very successfully done where the broadcast station whose program is picked up is not too far remote, and where static and natural conditions do not interfere too greatly. In the latter case, if these stations were allowed to pick up good short-wave programs from the larger stations with, of course, the permission of the originating station, these programs could be picked up at a greater distance and with greater clarity and less interference from static and other natural conditions.

Therefore, be it resolved, That the Board of Directors of the RMA recommend to the FCC that the restrictions regarding the pickup and rebroadcast of short-wave programs be eliminated and be on the same basis as those regulations governing the pickup and rebroadcast of programs from stations broadcasting on the standard broadcasting band, such pickups and rebroadcasting only to be done with the expressed permission of the originating station.

TAYLOR
VULCANIZED FIBRE
PHENOL FIBRE
TAYLOR INSULATION
TAYLOR & CO., INC. Norristown, Pa.

JACOBS ADJUSTABLE SEPARATOR
 (Improved)

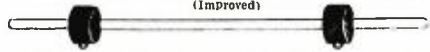

U. S. Patent 1,950,170—March 6, 1934—others pending
 Using this improved glass Separator 2 wire R. P. feedlines of any separation from 1" up to and including 9" (used in conjunction with Hertz Antenna Systems—Zepp Antennas) may be rapidly and efficiently constructed. \$1.75 for set of 6.

CHARLES F. JACOBS (W2EM)
 270 Lafayette St., New York, N. Y.

By Preference



In Cleveland ill.
 The HOLLENDEN

In Columbus ill.
 The NEIL HOUSE

In Dayton ill.
 The BILTMORE

In Akron ill.
 The MAYFLOWER

In Toledo ill.
 The NEW SECOR

In Savannah (Ga.) ill.
 The GENL OGLETHORPE

In Miami Beach ill.
 The FLEETWOOD

DeWitt Operated Hotels
feature
 Unusually Comfortable Rooms at Reasonable Rates and the finest of Food and Beverages. Carefully Prepared and Served.

Laminations and Stampings

• Standard stocks maintained for audio and power transformer laminations and shells and frames. Motor laminations a specialty. Big battery of presses for all type and weight stampings. Laboratory check maintained on all electrical steel used. Large stock raw material kept on hand for rush work.

TRY US—CATALOGUE ON REQUEST

• **WEBSTER-CHICAGO** •

Section M-N 21 3825 W. LAKE ST., CHICAGO, ILL.

Transformers



The finest transformers that engineering skill can design and modern machinery build. For radio, television and special applications.

THE ACME ELECTRIC AND MANUFACTURING CO.
 1444 HAMILTON AVENUE - CLEVELAND, OHIO

PAPER TUBES
 SPIRAL WRAPPED
 Square—Rectangular—Round
FOR COIL WINDING
 Write for Samples and Prices

PARAMOUNT PAPER TUBE CO.
 2035 CHARLESTON STREET CHICAGO, ILL.

GUTHMAN Coils



Guthman coils and trimmer condensers are dependable! There's one to fit every job! Send for samples & quotations Today! Edwin I. Guthman and Co., Inc. 400 S. Peoria St. Chicago

BLILEY QUARTZ CRYSTALS



For general and special radio frequency applications between 20Kcs and 20Mcs.
 Write for Bulletin G-8
BLILEY ELECTRIC CO.
 ERIE, PA.

INDEX TO ADVERTISERS

A	G	S
Acme Elec. & Mfg. Co., The..... 35	Gardiner Metal Co..... 36	Shakeproof Lock Washer Co..... 3
American Brass Co., The..... 31	Globe-Union Mfg. Co..... 29	Solar Mfg. Corp..... Fourth Cover
B	Guthman & Co., Inc., E. I..... 35	Stackpole Carbon Co..... 25
Bliley Electric Co..... 35	H	Sundt Engineering Co..... 33
Burstein-Appelheer Co..... 36	Holyoke Co., Inc., The..... 4	Superior Tube Co..... 23
C	I	Synthane Corp..... 17
Callite Products Division..... 34	Isolantite, Inc..... 27	T
Centralab..... 29	J	Taylor & Co., Inc..... 35
Crescent Insulated Wire & Cable Co., Inc..... 19	Jacobs, Charles F..... 35	Thomas & Skinner Steel Prod. Co. 34
Crowley Co., Inc., H. L..... Third Cover	Joslyn Mfg. & Supply Co..... 33	Thordarson Elec. & Mfg. Co..... 28
E	P	W
Electrical Products Co..... 36	Paramount Paper Tube Co..... 35	Ward Products Corp..... 36
Erie Resistor Corp..... Second Cover	R	Waterbury Brass Goods Branch..... 31
F	Railway Express Agency, Inc..... 31	Webster-Chicago..... 35
Ferranti Electric, Inc..... 20	Z	Willamsport Wire Rope Co..... 33
		Zophar Mills, Inc..... 36

EXTRA SAVINGS

are made possible through the use of Gardiner Rosin-Core Solder. Its uniform high quality permits experienced workers to do faster work and inexperienced help to do better, neater work. It saves both time and material.



In 1.5 and 20 lb. spools.

Made in various alloys and in gauges as fine as 1/32 of an inch. Because of modern production methods Gardiner Solder costs less than even ordinary kinds.

We also make bar and solid wire solders, and dipping and casting metals.

Eastern Sales Office and Warehouse

DAVID M. KASSON & CO.
264 Canal St., New York



4819 SO. CAMPBELL AVENUE, CHICAGO, ILL.

● WAXES ● COMPOUNDS ● VARNISHES

For Insulation of Condensers

Transformers, coils, power packs, pot heads, sockets, wiring devices, wet and dry batteries, etc. Also WAX SATURATORS for braided wire and tape WAXES for radio parts. Compounds made to your own specifications if you prefer.

● ZOPHAR MILLS, INC.

FOUNDED 1846

120-26th Street, Brooklyn, N. Y.

Laminations

for Audio and Power Transformers. Standard stocks in a wide range of sizes. Write for dimensions and price sheets.

Dies ... Tools ... Metal Stampings

● 35 years experience manufacturing all types of magnets

● Suppliers of ALNICO MAGNETS

Specialized methods ... Prompt service

THOMAS & SKINNER STEEL PRODUCTS CO.
1113 East 23rd Street Indianapolis, Ind.

LOW WHOLESALE PRICES

GET THIS FREE CATALOG!



Over 10,000 items in this big catalog including radio receivers, nationally known radio parts and broadcasting equipment. A catalog of great value to dealers and servicemen offering the best in radio at low wholesale prices. Write today for your FREE copy of this big catalog. Get your name on the list to receive monthly "Hot Shot" Bulletins sent to every Burstein-Applebee customer.

BURSTEIN-APPLEBEE CO.

1012-14 McGee Street

Kansas City, Mo.



THE EPKO STORAGE BATTERY ELIMINATOR

**GIVES RELIABLE ADJUSTABLE OUTPUT!
ENDS BATTERY-CHARGING NUISANCE!**

Convenient and Dependable

\$19.75 LIST PRICE (Usual Jobber Discount)

Providing 6 volt-10 amps. filtered D.C. from 110 volt A.C., the Epco Storage Battery Eliminator is specially designed for laboratory tests and demonstrating 6 volt automobile radios, small D. C. motors, magnets, solenoids, signals, relays and similar apparatus. Also used as an efficient battery charger. Forward order today or write for further technical details.

\$15.75 6 volt-5 amps. List Price (Usual Jobber Discount)

ELECTRICAL PRODUCTS CO.
6529 RUSSELL STREET · DETROIT, MICH.

The Walton Hotel PHILADELPHIA

... where a hearty welcome awaits you always. Here you will find quiet, comfortable rooms, courteous service and excellent food.

350 ROOMS WITH BATH
GARAGE FACILITIES ... RATES BEGIN AT \$2.50

BROAD STREET AT LOCUST

AERIALS FOR 1937

What Will **WARD PRODUCTS** Show for 1937?

TOP AERIALS • WHIPS • POLES
RUNNING BOARD AERIALS

AUTOMOBILE

WARD PRODUCTS CORP.
Cleveland, O.

CANADA: ATLAS RADIO CORP., TORONTO, ONT.
FOREIGN: LINCOLN EXPORT CO., N. Y.

USE THIS COUPON

WARD PRODUCTS CORP.
Ward Bldg. - Cleveland, O.

Send information of Ward's 1937 Auto Aerials.

Name _____
Address _____

Check Dealer Jobber Service Man

Communication and Broadcast Engineering

Covering Radio Communication, Broadcasting, Police, Marine and Aeronautical Radio, Telephony and Telegraphy, Facsimile and Television.
Published monthly.

●
SUBSCRIPTION, \$3.00 YEARLY
(Foreign \$4.00)

●
BRYAN DAVIS PUBLISHING CO., Inc.
19 East 47th Street New York, N. Y.

AHEAD OF THE TIMES!

Specify

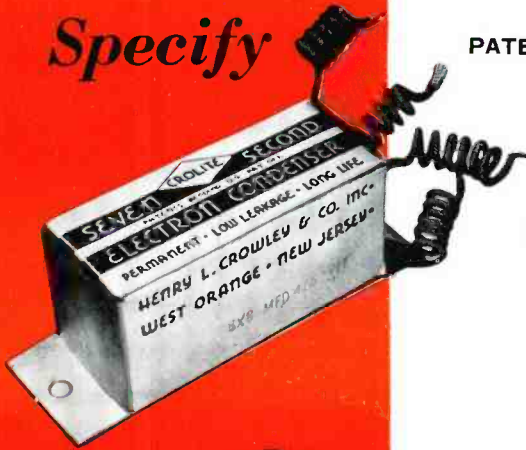

PATENTED



PROCESS

CONDENSERS

Wide Use.
Exceptional Results.
Sets Stay Out.
Returns Disappear.
Support High Overloads and A.C. Ripples.
QUALITY THROUGHOUT

MAGICORES

Use Broadens Every
Day. New Uses, New Shapes,
gives greater and greater per-
formance results. Possibilities of set
improvement by simple changes.

MERITS MOST CAREFUL ENGINEERING
CONSIDERATION



CERAMICS

Molded ceramics of
real low loss mate-
rials. New possibili-
ties. Why not consider
them?

LIQUID CROLITE SUPER QUARTZ

A liquid for impreg-
nating and covering
purposes with losses
lower than fused
quartz.

Write for Technical Data

Condensers:

Magicores:

Resistors:

Ceramics:

HENRY L. CROWLEY CO., Inc.

1 CENTRAL AVE., WEST ORANGE, N. J.



QUALITY ABOVE ALL

Solar
DOMINO
molded BAKELITE paper capacitors

SOLAR MANUFACTURING CORP. 59-601 BROADWAY, NEW YORK